

# Dell PowerEdge R220 Owner's Manual

Regulatory Model: E10S  
Regulatory Type: E10S003



# Notes, Cautions, and Warnings

 **NOTE:** A NOTE indicates important information that helps you make better use of your computer.

 **CAUTION:** A CAUTION indicates either potential damage to hardware or loss of data and tells you how to avoid the problem.

 **WARNING:** A WARNING indicates a potential for property damage, personal injury, or death.

**Copyright © 2014 Dell Inc. All rights reserved.** This product is protected by U.S. and international copyright and intellectual property laws. Dell™ and the Dell logo are trademarks of Dell Inc. in the United States and/or other jurisdictions. All other marks and names mentioned herein may be trademarks of their respective companies.

2014 - 04

Rev. A00

# Contents

<b>1 About Your System.....</b>	<b>7</b>
Front-Panel Features And Indicators.....	7
Back-Panel Features And Indicators.....	9
NIC Indicator Codes.....	10
Related Documentation.....	10
Quick Resource Locator.....	11
<b>2 Using The System Setup And Boot Manager.....</b>	<b>13</b>
Choosing The System Boot Mode.....	13
Entering System Setup.....	14
Responding To Error Messages.....	14
Using The System Setup Navigation Keys.....	14
System Setup Options.....	15
System And Setup Password Features.....	22
Entering The UEFI Boot Manager.....	24
Embedded System Management.....	25
iDRAC Settings Utility.....	25
<b>3 Installing System Components.....</b>	<b>27</b>
Recommended Tools.....	27
Front Bezel (Optional).....	27
Installing The Front Bezel.....	27
Removing The Front Bezel.....	27
Opening And Closing The System.....	28
Opening The System.....	28
Closing The System.....	29
Inside The System.....	29
Chassis Intrusion Switch.....	30
Removing The Chassis Intrusion Switch.....	30
Installing The Chassis Intrusion Switch.....	31
Optical Drive (Optional).....	31
Removing The Optical Drive .....	31
Installing The Optical Drive .....	32
Hard Drives.....	33
Removing A 3.5 Inch Hard-Drive Cage.....	33
Installing A 3.5 Inch Hard-Drive Cage.....	35
Removing A 3.5 Inch Hard Drive From The Hard-Drive Cage.....	36
Installing A 3.5 Inch Hard Drive Into The Hard-Drive Cage.....	36

Removing A 2.5 Inch Hard-Drive Cage.....	37
Installing A 2.5 Inch Hard-Drive Cage.....	38
Removing A 2.5 Inch Hard Drive From The Hard-Drive Cage.....	39
Installing A 2.5 Inch Hard Drive Into The Hard-Drive Cage.....	39
LED Module.....	40
Removing The LED Module.....	40
Installing The LED Module.....	41
Control-Panel Board.....	41
Removing The Control-Panel Board.....	41
Installing The Control-Panel Board.....	42
Cooling Fans.....	43
Removing A Cooling Fan.....	43
Installing A Cooling Fan.....	44
Cooling Shroud.....	45
Removing The Cooling Shroud.....	45
Installing The Cooling Shroud.....	46
System Memory.....	46
General Memory Module Installation Guidelines.....	47
Sample Memory Configurations.....	47
Removing Memory Modules.....	48
Installing Memory Modules.....	49
Internal USB Memory Key (Optional).....	50
Removing And Installing The Internal USB Key.....	50
Expansion Cards And Expansion-Card Risers.....	51
Expansion Card Installation Guidelines.....	51
Expansion Card Types And Form Factor.....	51
Removing An Expansion Card.....	52
Installing An Expansion Card.....	53
Removing The Expansion-Card Riser.....	53
Installing The Expansion-Card Riser.....	54
iDRAC7 Enterprise Card (Optional).....	55
Removing The iDRAC7 Enterprise Card.....	55
Installing The iDRAC7 Enterprise Card.....	56
System Battery.....	57
Replacing The System Battery.....	57
Processor.....	58
Removing The Processor.....	58
Installing The Processor.....	60
Power Supply Unit.....	61
Removing The Power Supply Unit.....	62
Installing The Power Supply.....	63
System Board.....	63

Removing The System Board.....	63
Installing The System Board.....	64
<b>4 Troubleshooting Your System.....</b>	<b>67</b>
Safety First—For You And Your System.....	67
Troubleshooting System Startup Failure.....	67
Troubleshooting External Connections.....	67
Troubleshooting The Video Subsystem.....	67
Troubleshooting A USB Device.....	67
Troubleshooting A Serial I/O Device.....	68
Troubleshooting A NIC.....	68
Troubleshooting A Wet System.....	69
Troubleshooting A Damaged System.....	69
Troubleshooting The System Battery.....	70
Troubleshooting The Power Supply.....	71
Troubleshooting Cooling Problems.....	71
Troubleshooting Cooling Fans.....	71
Troubleshooting System Memory.....	72
Troubleshooting An Internal USB Key.....	73
Troubleshooting An SD Card.....	73
Troubleshooting An Optical Drive.....	74
Troubleshooting A Hard Drive.....	74
Troubleshooting Expansion Cards.....	75
Troubleshooting The Processor.....	76
<b>5 Using System Diagnostics.....</b>	<b>77</b>
Dell Embedded System Diagnostics.....	77
When To Use The Embedded System Diagnostics.....	77
Running The Embedded System Diagnostics.....	77
System Diagnostic Controls.....	77
<b>6 Jumpers And Connectors.....</b>	<b>79</b>
System Board Jumper Settings.....	79
System Board Connectors.....	80
Disabling A Forgotten Password.....	81
<b>7 Technical Specifications.....</b>	<b>83</b>
<b>8 System Messages.....</b>	<b>87</b>
System Error Messages.....	87
Warning Messages.....	96
Diagnostic Messages.....	96

Alert Messages.....	96
<b>9 Getting Help.....</b>	<b>97</b>
Contacting Dell.....	97
Locating Your System Service Tag.....	97
Documentation Feedback.....	97
Quick Resource Locator.....	97

# About Your System

## Front-Panel Features And Indicators

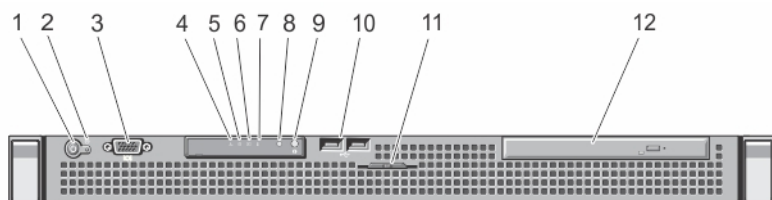











Figure 1. Front-Panel Features and Indicators

Item	Indicator, Button, or Connector	Icon	Description
1	Power-on indicator, power button		<p>The power-on indicator lights when the system power is on. The power button controls the power supply output to the system.</p> <p> <b>NOTE:</b> On ACPI-compliant operating systems, turning off the system using the power button causes the system to perform a graceful shutdown before power to the system is turned off.</p>
2	NMI button		<p>Used to troubleshoot software and device driver errors when running certain operating systems. This button can be pressed using the end of a paper clip.</p> <p>Use this button only if directed to do so by qualified support personnel or if the information is provided in the operating system documentation.</p>
3	Video connector		Allows you to connect a VGA display to the system.
4	Temperature indicator		<p>The indicator blinks amber if the system experiences a thermal error (for example, a temperature out of range or fan failure).</p> <p>Ensure that none of the following conditions exist:</p> <ul style="list-style-type: none"> <li>• A cooling fan is removed or has failed.</li> <li>• System cover, cooling shroud, EMI filler panel, memory-module blank, or back-filler bracket is removed.</li> <li>• Ambient temperature is too high.</li> </ul>

Item	Indicator, Button, or Connector	Icon	Description
			<ul style="list-style-type: none"> <li>External airflow is obstructed.</li> </ul> <p>See <a href="#">Getting Help</a>.</p>
5	Electrical indicator		<p>The indicator blinks amber if the system experiences an electrical error (for example, voltage out of range, or a failed power supply or voltage regulator).</p> <p>See the System Event Log or system messages for the specific issue. Re-seat the power supply by removing and reinstalling it. If the problem persists, see <a href="#">Getting Help</a>.</p>
6	Hard-drive indicator		<p>The indicator blinks green to indicate hard-drive activity.</p>
7	Health indicator		<p>If the system is on, and in good health, the indicator lights solid blue.</p> <p>The indicator blinks amber if the system is on or in standby, and any error exists (for example, a failed fan or hard drive).</p>
8	System status indicator		<p>Lights blue during normal system operation.</p> <p>Lights amber when the system needs attention due to a problem.</p> <ul style="list-style-type: none"> <li>See the System Event Log or system messages for the specific issue.</li> <li>Invalid memory configurations can cause the system to halt at startup without any video output. See <a href="#">Getting Help</a>.</li> </ul>
9	System identification button		<p>The identification buttons on the front and back panels can be used to locate a particular system within a rack. When one of these buttons is pressed, the system status indicator on the front and the back of the system flashes until one of the buttons is pressed again.</p> <p>Press to toggle the system ID on and off.</p> <p>If the system stops responding during POST, press and hold the system ID button for more than five seconds to enter BIOS progress mode.</p> <p>To reset iDRAC (if not disabled in the <b>iDRAC Settings</b> option) press and hold the button for more than 15 seconds.</p>
10	USB connectors (2)		<p>Allow you to connect USB devices to the system. The ports are USB 2.0-compliant.</p>
11	System service tag		<p>A slide-out label panel that allows you to record system information such as Service Tag, NIC, MAC address, and so on as per your need.</p>



Item	Indicator, Button, or Connector	Icon	Description
12	Optical drive (optional)		One optional slim SATA DVD-ROM drive or DVD +/-RW drive.

## Back-Panel Features And Indicators

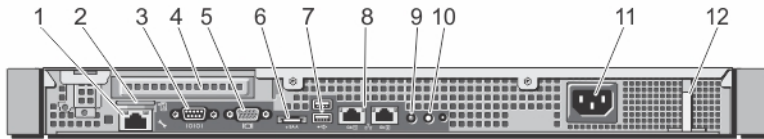









Figure 2. Back-Panel Features and Indicators

Item	Indicator, Button, or Connector	Icon	Description
1	iDRAC7 Enterprise port (optional)		Dedicated management port for the iDRAC7 Enterprise card.
2	vFlash media card slot (optional)		Allows you to connect the optional vFlash media card.
3	Serial connector		Allows you to connect a serial device to the system.
4	PCIe expansion card slot		Allows you to connect one low-profile PCI Express expansion card.
5	Video connector		Allows you to connect a VGA display to the system.
6	eSATA		Allows you to connect additional storage devices.
7	USB connectors (2)		Allow you to connect USB devices to the system. The ports are USB 3.0-compliant.
8	Ethernet connectors (2)		Two integrated 10/100/1000 Mbps NIC connectors.
9	System status indicator		Indicates the status of the system. Lights blue during normal system operation. Lights amber when the system needs attention due to a problem.
10	System identification button		The identification buttons on the front and back panels can be used to locate a particular system within a rack. When one of these buttons is pressed, the system status indicator on the back flashes until one of the buttons is pressed again. Press to toggle the system ID on and off. If the system stops responding during POST, press and hold the system ID button for more than five seconds to enter BIOS progress mode.

Item	Indicator, Button, or Connector	Icon	Description
			To reset iDRAC (if not disabled in the <b>iDRAC Settings</b> option) press and hold the button for more than 15 seconds.
11	Power supply		250 W AC power supply.
12	Retention clip		Secures the power cable.

## NIC Indicator Codes

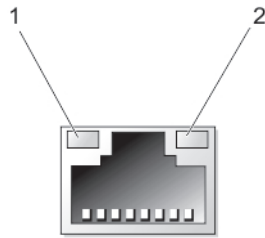

Figure 3. NIC Indicator

- link indicator
- activity indicator

Indicator	Indicator Code
Link and activity indicators are off	The NIC is not connected to the network.
Link indicator is green	The NIC is connected to a valid network at its maximum port speed (1 Gbps or 10 Gbps).
Link indicator is amber	The NIC is connected to a valid network at less than its maximum port speed.
Activity indicator is blinking green	Network data is being sent or received.

## Related Documentation

**WARNING:** See the safety and regulatory information that shipped with your system. Warranty information may be included within this document or as a separate document.

**NOTE:** For all PowerEdge and PowerVault documentation, go to [dell.com/support/manuals](http://dell.com/support/manuals) and enter the system Service Tag to get your system documentation.

**NOTE:** For all Dell OpenManage documents, go to [dell.com/openmanagemanuals](http://dell.com/openmanagemanuals).

**NOTE:** For all operating system documents, go to [dell.com/operatingsystemmanuals](http://dell.com/operatingsystemmanuals).

**NOTE:** For all storage controllers and PCIe SSD documents, go to [dell.com/storagecontrollermanuals](http://dell.com/storagecontrollermanuals).

Your product documentation includes:

- The *Owner's Manual*, which provides information about system features and describes how to troubleshoot the system and install or replace system components. This document is available online at [dell.com/support/manuals](http://dell.com/support/manuals).
- The rack documentation included with your rack solution describes how to install your system into a rack, if required.
- Any media that ships with your system provides documentation and tools for configuring and managing your system, including those pertaining to the operating system, system management software, system updates, and system components that you purchased with your system.
- The *Administrator's Guide*, which provides information about configuring and managing the system.

 **NOTE:** Always check for updates on [dell.com/support/manuals](http://dell.com/support/manuals) and read the updates first because they often supersede information in other documents.

 **NOTE:** When upgrading your system, it is recommended that you download and install the latest BIOS, driver, and systems management firmware on your system from [dell.com/support](http://dell.com/support).

## Quick Resource Locator

Use the Quick Resource Locator (QRL) to get immediate access to system information and how-to videos. This can be done by visiting [dell.com/QRL](http://dell.com/QRL) or by using your smartphone and a model specific Quick Resource (QR) code located on your Dell PowerEdge system. To try out the QR code, scan the following image.





# Using The System Setup And Boot Manager

System Setup enables you to manage your system hardware and specify BIOS-level options.

The following keystrokes provide access to system features during startup:

Keystroke	Description
<F2>	Enters the System Setup.
<F10>	Enters System Services, which opens the Dell Lifecycle Controller 2 (LC2). The Dell LC2 supports systems management features such as operating system deployment, hardware diagnostics, firmware updates, and platform configuration, using a graphical user interface. The exact LC2 feature set is determined by the iDRAC license purchased. For more information, see the Dell LC2 documentation at <a href="http://dell.com/esmmanuals">dell.com/esmmanuals</a> .
<F11>	Enters the BIOS Boot Manager or the Unified Extensible Firmware Interface (UEFI) Boot Manager, depending on the system's boot configuration.
<F12>	Starts Preboot Execution Environment (PXE) boot.

From the System Setup, you can:

- Change the NVRAM settings after you add or remove hardware.
- View the system hardware configuration.
- Enable or disable integrated devices.
- Set performance and power management thresholds.
- Manage system security.

You can access the System Setup using the:

- Standard graphical browser, which is enabled by default.
- Text browser, which is enabled using **Console Redirection**.

To enable **Console Redirection**, in **System Setup**, select **System BIOS** → **Serial Communication screen** → **Serial Communication**, select **On with Console Redirection**.

 **NOTE:** By default, help text for the selected field is displayed in the graphical browser. To view the help text in the text browser, press <F1>.

## Choosing The System Boot Mode

System Setup enables you to specify the boot mode for installing your operating system:

- BIOS boot mode (the default) is the standard BIOS-level boot interface.
- UEFI boot mode is an enhanced 64-bit boot interface based on Unified Extensible Firmware Interface (UEFI) specifications that overlays the system BIOS.

You must select the boot mode in the **Boot Mode** field of the **Boot Settings** screen of System Setup. After you specify the boot mode, the system boots in the specified boot mode and you then proceed to install your operating system from that mode. Thereafter, you must boot the system in the same boot mode (BIOS or UEFI) to access the installed operating system. Trying to boot the operating system from the other boot mode will cause the system to halt at startup.

 **NOTE:** Operating systems must be UEFI-compatible to be installed from the UEFI boot mode. DOS and 32-bit operating systems do not support UEFI and can only be installed from the BIOS boot mode.

 **NOTE:** For the latest information on supported operating systems, go to [dell.com/ossupport](http://dell.com/ossupport).

## Entering System Setup

1. Turn on or restart your system.
2. Press **<F2>** immediately after you see the following message:

`<F2> = System Setup`

If your operating system begins to load before you press **<F2>**, allow the system to finish booting, and then restart your system and try again.

## Responding To Error Messages

If an error message is displayed while the system is booting, make a note of the message. For more information, see [System Error Messages](#).

 **NOTE:** After installing a memory upgrade, it is normal for your system to display a message the first time you start your system.

## Using The System Setup Navigation Keys

Keystroke	Action
Up arrow	Moves to the previous field.
Down arrow	Moves to the next field.
<Enter>	Allows you to type in a value in the selected field (if applicable) or follow the link in the field.
Spacebar	Expands or collapses a drop-down menu, if applicable.
<Tab>	Moves to the next focus area.
	 <b>NOTE:</b> For the standard graphics browser only.
<Esc>	Moves to the previous page till you view the main screen. Pressing <Esc> in the main screen displays a message that prompts you to save any unsaved changes and restarts the system.
<F1>	Displays the System Setup help file.

Keystroke	Action
-----------	--------

 **NOTE:** For most of the options, any changes that you make are recorded but do not take effect until you restart the system.

## System Setup Options

### System Setup Main Screen

 **NOTE:** Press <Alt><F> to reset the BIOS or UEFI settings to their default settings.

Menu Item	Description
System BIOS	This option is used to view and configure BIOS settings.
iDRAC Settings	This option is used to view and configure iDRAC settings.
Device Settings	This option is used to view and configure device settings.

### System BIOS Screen

 **NOTE:** The options for System Setup change based on the system configuration.

 **NOTE:** System Setup defaults are listed under their respective options in the following sections, where applicable.

Menu Item	Description
System Information	Displays information about the system such as the system model name, BIOS version, Service Tag, and so on.
Memory Settings	Displays information and options related to installed memory.
Processor Settings	Displays information and options related to the processor such as speed, cache size, and so on.
SATA Settings	Displays options to enable or disable the integrated SATA controller and ports.
Boot Settings	Displays options to specify the boot mode (BIOS or UEFI). Enables you to modify UEFI and BIOS boot settings.
Integrated Devices	Displays options to enable or disable integrated device controllers and ports, and to specify related features and options.
Serial Communication	Displays options to enable or disable the serial ports and specify related features and options.
System Profile Settings	Displays options to change the processor power management settings, memory frequency, and so on.
System Security	Displays options to configure the system security settings like, system password, setup password, TPM security, and so on. It also enables or disables the power and NMI buttons on the system.
Miscellaneous Settings	Displays options to change the system date, time, and so on.

## System Information Screen

Menu Item	Description
System Model Name	Displays the system model name.
System BIOS Version	Displays the BIOS version installed on the system.
System Service Tag	Displays the system Service Tag.
System Manufacturer	Displays the name of system manufacturer.
System Manufacturer Contact Information	Displays the contact information of the system manufacturer.
System CPLD Version	Displays the CPLD version of the system.

## Memory Settings Screen

Menu Item	Description
System Memory Size	Displays the amount of memory installed in the system.
System Memory Type	Displays the type of memory installed in the system.
System Memory Speed	Displays the system memory speed.
System Memory Voltage	Displays the system memory voltage.
Video Memory	Displays the amount of video memory.
System Memory Testing	Specifies whether system memory tests are run during system boot. Options are <b>Enabled</b> and <b>Disabled</b> . By default, the <b>System Memory Testing</b> option is set to <b>Disabled</b> .

## Processor Settings Screen

Menu Item	Description
Logical Processor	Allows you to enable or disable logical processors and display the number of logical processors. If the <b>Logical Processor</b> option is set to <b>Enabled</b> , the BIOS displays all the logical processors. If this option is set to <b>Disabled</b> , the BIOS only displays one logical processor per core. By default, the <b>Logical Processor</b> option is set to <b>Enabled</b> .
Virtualization Technology	Allows you to enable or disable the additional hardware capabilities provided for virtualization. By default, the <b>Virtualization Technology</b> option is set to <b>Enabled</b> .



Menu Item	Description
Adjacent Cache Line Prefetch	Allows you to optimize the system for applications that require high utilization of sequential memory access. By default, the <b>Adjacent Cache Line Prefetch</b> option is set to <b>Enabled</b> . You can disable this option for applications that require high utilization of random memory access.
Hardware Prefetcher	Allows you to enable or disable hardware prefetcher. By default, the <b>Hardware Prefetcher</b> option is set to <b>Enabled</b> .
DCU Streamer Prefetcher	Allows you to enable or disable Data Cache Unit streamer prefetcher. By default, the <b>DCU Streamer Prefetcher</b> option is set to <b>Enabled</b> .
DCU IP Prefetcher	Allows you to enable or disable Data Cache Unit IP prefetcher. By default, the <b>DCU IP Prefetcher</b> option is set to <b>Enabled</b> .
Execute Disable	Allows you enable or disable execute disable memory protection technology. By default, the <b>Execute Disable</b> option is set to <b>Enabled</b> .
Number of Cores per Processor	Allows you to control the number of enabled cores in each processor. By default, the <b>Number of Cores per Processor</b> option is set to <b>All</b> .
Processor 64-bit Support	Specifies if the processor(s) support 64-bit extensions.
Processor Core Speed	Displays the maximum core frequency of the processor.
Family-Model-Stepping	Displays the family, model and stepping of the processor as defined by Intel.
Brand	Displays the brand name reported by the processor.
Level 2 Cache	Displays the total L2 cache.
Level 3 Cache	Displays the total L3 cache.
Number of Cores	Displays the number of cores per processor.





### SATA Settings Screen

Menu Item	Description
Embedded SATA	Allows the embedded SATA to be set to Off, ATA, AHCI, or RAID mode. By default, Embedded SATA is set to <b>AHCI Mode</b> .
Port A	Auto enables BIOS support for the device attached to SATA port A. By default, Port A is set to <b>Auto</b> .
Port B	Auto enables BIOS support for the device attached to SATA port B. By default, Port B is set to <b>Auto</b> .
eSATA	Auto enables BIOS support for the device attached to the eSATA port . By default, eSATA port is set to <b>Auto</b> .



**NOTE:** Ports A and B are used for the hard drives, eSATA port is used for external hard drives and for the optical drive (CD/DVD).

## Boot Settings Screen



Menu Item	Description
Boot Mode	<p>Allows you to set the boot mode of the system.</p> <p> <b>CAUTION: Switching the boot mode may prevent the system from booting if the operating system is not installed in the same boot mode.</b></p> <p>If the operating system supports UEFI, you can set this option to UEFI. Setting this field to BIOS allows compatibility with non-UEFI operating systems. By default, the <b>Boot Mode</b> option is set to <b>BIOS</b>.</p> <p> <b>NOTE:</b> Setting this field to UEFI disables BIOS Boot Settings menu. Setting this field to BIOS disables the UEFI Boot Settings menu.</p>
Boot Sequence Retry	<p>Allows you to enable or disable the boot sequence retry feature. If this field is enabled and the system fails to boot, the system reattempts the boot sequence after 30 seconds. By default, the <b>Boot Sequence Retry</b> option is set to <b>Disabled</b>.</p>
BIOS Boot Settings	<p>Allows you to enable or disable BIOS Boot options.</p> <p> <b>NOTE:</b> This option is enabled only if the boot mode is BIOS.</p>
UEFI Boot Settings	<p>Allows you to enable or disable UEFI Boot options. The Boot options include <b>IPv4 PXE</b> and <b>IPv6 PXE</b>. By default, the <b>UEFI PXE boot protocol</b> is set to <b>IPv4</b>.</p> <p> <b>NOTE:</b> This option is enabled only if the boot mode is UEFI.</p>
One-Time Boot	<p>Allows you to enable or disable a one-time boot from a selected device.</p>

## Integrated Devices Screen

Menu Item	Description
User Accessible USB Ports	<p>Allows you enable or disable the user accessible USB ports. Selecting <b>Only Back Ports On</b> disables the front USB ports and selecting <b>All Ports Off</b> disables both front and back USB ports. By default, the <b>User Accessible USB Ports</b> option is set to <b>All Ports On</b>.</p>
Internal USB Port	<p>Allows you to enable or disable the internal USB port. By default, the <b>Internal USB Port</b> option is set to <b>On</b>.</p>
Embedded NIC1 and NIC2	<p>Allows you to enable or disable the embedded network interface cards 1 and 2. By default, the <b>Integrated Network Card 1</b> option is set to <b>Enabled</b>.</p>
OS Watchdog Timer	<p>Allows you to enable or disable the OS watchdog timer. When this field is enabled, the operating system initializes the timer and the OS watchdog timer helps in recovering the operating system. By default, the <b>OS Watchdog Timer</b> option is set to <b>Disabled</b>.</p>
Embedded Video Controller	<p>Allows you to enable or disable the <b>Embedded Video Controller</b>. By default, the embedded video controller is <b>Enabled</b>.</p>

Menu Item	Description
SR-IOV Global Enable	Allows you to enable or disable the BIOS configuration of Single Root I/O Virtualization (SR-IOV) devices. By default, the <b>SR-IOV Global Enable</b> option is set to <b>Disabled</b> .
Memory Mapped I/O above 4GB	Allows you to enable support for PCIe devices that require large amounts of memory. By default, the option is set to <b>Enabled</b> .
Slot Disablement	Allows you to enable or disable available PCIe slots on your system. The <b>Slot Disablement</b> feature controls the configuration of PCIe cards installed in the specified slot.   <b>CAUTION: Slot disablement must be used only when the installed peripheral card is preventing booting into the Operating System or causing delays in system startup. If the slot is disabled, both the Option ROM and UEFI driver are disabled.</b>

### Serial Communications Screen

Menu Item	Description
Serial Communication	Allows you to select serial communication devices (Serial Device 1 and Serial Device 2) in the BIOS. BIOS console redirection can also be enabled and the port address used can be specified. By default, <b>Serial Communication</b> option is set to <b>On without Console Redirection</b> .
Serial Port Address	Allows you to set the port address for serial devices. By default, the <b>Serial Port Address</b> option is set to <b>Serial Device 1=COM2, Serial Device 2=COM1</b> .   <b>NOTE:</b> Only Serial Device 2 can be used for Serial Over LAN (SOL). To use console redirection by SOL, configure the same port address for console redirection and the serial device.
External Serial Connector	Allows you to associate the external serial connector to serial device 1, serial device 2, or remote access device. By default, the <b>External Serial Connector</b> option is set to <b>Serial Device1</b> .   <b>NOTE:</b> Only Serial Device 2 can be used for SOL. To use console redirection by SOL, configure the same port address for console redirection and the serial device.
Failsafe Baud Rate	Displays the failsafe baud rate for console redirection. The BIOS attempts to determine the baud rate automatically. This failsafe baud rate is used only if the attempt fails and the value must not be changed. By default, the <b>Failsafe Baud Rate</b> option is set to <b>115200</b> .
Remote Terminal Type	Allows you to set the remote console terminal type. By default, the <b>Remote Terminal Type</b> option is set to <b>VT 100/VT 220</b> .
Redirection After Boot	Allows you to enable or disable to the BIOS console redirection when the operating system is loaded. By default, the <b>Redirection After Boot</b> option is set to <b>Enabled</b> .

## System Profile Settings Screen

Menu Item	Description
System Profile	Allows you to set the system profile. If you set the <b>System Profile</b> option to a mode other than <b>Custom</b> , the BIOS automatically sets the rest of the options. You can only change the rest of the options if the mode is set to <b>Custom</b> . By default, the <b>System Profile</b> option is set to <b>Performance Per Watt Optimized (OS)</b> .  <b>NOTE:</b> The following parameters are available only when the <b>System Profile</b> is set to <b>Custom</b> .
CPU Power Management	Allows you to set the CPU power management. By default, the <b>CPU Power Management</b> option is set to <b>System OS DBPM</b> . DBPM is Demand-Based Power Management.
Memory Frequency	Allows you to set the memory frequency. By default, the <b>Memory Frequency</b> option is set to <b>Maximum Performance</b> .
Turbo Boost	Allows you to enable or disable the processor to operate in turbo boost mode. By default, the <b>Turbo Boost</b> option is set to <b>Enabled</b> .
C1E	Allows you to enable or disable the processor to switch to a minimum performance state when it is idle. By default, the <b>C1E</b> option is set to <b>Enabled</b> .
C States	Allows you to enable or disable the processor to operate in all available power states. By default, the <b>C States</b> option is set to <b>Enabled</b> .
Memory Refresh Rate	Allows you to set the memory refresh rate. By default, the <b>Memory Refresh Rate</b> option is set to <b>1x</b> .

## System Security Screen

Menu Item	Description
Intel(R) AES-NI	The <b>Intel(R) AES-NI</b> option improves the speed of applications by performing encryption and decryption using the Advanced Encryption Standard Instruction Set and is set to <b>Enabled</b> by default.
System Password	Allows you to set the system password. This option is read-only if the password jumper is not installed in the system.
Setup Password	Allows you to set the setup password. This option is read-only if the password jumper is not installed in the system.
Password Status	Allows you to lock the system password. By default, the <b>Password Status</b> option is set to <b>Unlocked</b> .
TPM Security	Allows you to control the reporting mode of the Trusted Platform Module (TPM). By default, the <b>TPM Security</b> option is set to <b>Off</b> . You can only modify the TPM Status, TPM Activation, TPM Clear, and Intel TXT fields if the <b>TPM Security</b> field is set to either <b>On with Pre-boot Measurements</b> or <b>On without Pre-boot Measurements</b> .
TPM Status	Displays the TPM status.

Menu Item	Description
TPM Activation	Allows you to change the operational state of the TPM. By default, the <b>TPM Activation</b> option is set to <b>No Change</b> .
TPM Clear	 <b>CAUTION: Clearing the TPM results in loss of all keys in the TPM. The loss of TPM keys may affect booting to the operating system.</b> Allows you to clear all the contents of the TPM. By default, the <b>TPM Clear</b> option is set to <b>No</b> .
Intel(R) TXT	Allows you enable or disable Intel Trusted Execution Technology. To enable <b>Intel TXT, Virtualization Technology</b> must be enabled and <b>TPM Security</b> must be <b>Enabled</b> with Pre-boot measurements. By default, the <b>Intel TXT</b> option is set to <b>Off</b> .
Power Button	Allows you to enable or disable the power button on the front of the system. By default, the <b>Power Button</b> option is set to <b>Enabled</b> .
NMI Button	Allows you to enable or disable the NMI button on the front of the system. By default, the <b>NMI Button</b> option is set to <b>Disabled</b> .
AC Power Recovery	Allows you to set how the system reacts after AC power is restored to the system. By default, the <b>AC Power Recovery</b> option is set to <b>Last</b> .
AC Power Recovery Delay	Allows you to set how the system supports staggering of power up after AC power is restored to the system. By default, the <b>AC Power Recovery Delay</b> option is set to <b>Immediate</b> .
User Defined Delay (60s to 240s)	Allows you to set the <b>User Defined Delay</b> when the <b>User Defined</b> option for <b>AC Power Recovery Delay</b> is selected.

### Miscellaneous Settings

Menu Item	Description
System Date	Allows you to set the date on the system.
System Time	Allows you to set the time on the system.
Asset Tag	Displays the asset tag and allows you to modify it for security and tracking purposes.
Keyboard NumLock	Allows you to set whether the system boots with the NumLock enabled or disabled. By default the <b>Keyboard NumLock</b> is set to <b>On</b> .   <b>NOTE:</b> This field does not apply to 84-key keyboards.
Report Keyboard Errors	Allows you to set whether keyboard-related error messages are reported during system boot. By default, the <b>Report Keyboard Errors</b> field is set to <b>Report</b> .
F1/F2 Prompt on Error	Allows you to enable or disable the F1/F2 prompt on error. By default, <b>F1/F2 Prompt on Error</b> is set to <b>Enabled</b> .

## System And Setup Password Features

You can create a system password and a setup password to secure your system. To enable creation of the system and setup password, the password jumper must be set to enabled. For more information on the password jumper settings, see [System Board Jumper Settings](#).

<b>System password</b>	This is the password that you must enter before you can boot your system.
<b>Setup password</b>	This is the password that you must enter to access and make changes to the BIOS or UEFI settings of your system.

 **CAUTION: The password features provide a basic level of security for the data on your system.**

 **CAUTION: Anyone can access the data stored on your system if the system is running and unattended.**

 **NOTE:** Your system is shipped with the system and setup password feature disabled.

### Assigning A System And/Or Setup Password

 **NOTE:** The password jumper enables or disables the System Password and Setup Password features. For more information on the password jumper settings, see System Board Jumper Settings.

You can assign a new **System Password** and/or **Setup Password** or change an existing **System Password** and/or **Setup Password** only when the password jumper setting is enabled and **Password Status** is **Unlocked**. If the Password Status is **Locked**, you cannot change the System Password.

If the password jumper setting is disabled, the existing System Password and Setup Password is deleted and you need not provide the system password to log on to the system.

To assign a system and/or setup password:

1. To enter System Setup, press <F2> immediately after a power-on or reboot.
2. In the **System Setup Main Menu**, select **System BIOS** and press <Enter>. The **System BIOS** screen is displayed.
3. In the **System BIOS** screen, select **System Security** and press <Enter>. The **System Security** screen is displayed.
4. In the **System Security** screen, verify that **Password Status** is **Unlocked**.
5. Select **System Password**, enter your system password, and press <Enter> or <Tab>. Use the following guidelines to assign the system password:
  - A password can have up to 32 characters.
  - The password can contain the numbers 0 through 9.
  - Only lower case letters are valid, upper case letters are not allowed.
  - Only the following special characters are allowed: space, ("), (+), (.), (-), (.), (/), (:), (I), (\), (l), (').

A message prompts you to re-enter the system password.

6. Re-enter the system password that you entered earlier and click **OK**.
7. Select **Setup Password**, enter your system password and press <Enter> or <Tab>. A message prompts you to re-enter the setup password.

8. Re-enter the setup password that you entered earlier and click **OK**.
9. Press <Esc> to return to the **System BIOS** screen. Press <Esc> again, and a message prompts you to save the changes.

 **NOTE:** Password protection does not take effect until the system reboots.

### Deleting Or Changing An Existing Setup Password

Ensure that the Password jumper is set to enabled and the **Password Status** is **Unlocked** before attempting to delete or change the existing System and/or Setup password. You cannot delete or change an existing System password if the **Password Status** is **Locked**.

To delete or change the existing System and/or Setup password:

1. To enter System Setup, press <F2> immediately after a power-on or reboot.
2. In the **System Setup Main Menu**, select **System BIOS** and press <Enter>. The **System BIOS** screen is displayed.
3. In the **System BIOS Screen**, select **System Security** and press <Enter>. The **System Security** screen is displayed.
4. In the **System Security** screen, verify that **Password Status** is **Unlocked**.
5. Select **System Password**, alter or delete the existing system password and press <Enter> or <Tab>.
6. Select **Setup Password**, alter or delete the existing setup password and press <Enter> or <Tab>.

 **NOTE:** If you change the System and/or Setup password a message prompts you to re-enter the new password. If you delete the System and/or Setup password, a message prompts you to confirm the deletion.

7. Press <Esc> to return to the System BIOS screen. Press <Esc> again, and a message prompts you to save the changes.

 **NOTE:** You can disable password security while logging on to the system. To disable the password security, turn on or reboot your system, type your password and press <Ctrl><Enter>.

### Using Your System Password To Secure Your System

 **NOTE:** If you have assigned a setup password, the system accepts your setup password as an alternate system password.

1. Turn on or reboot your system.
2. Type your password and press <Enter>.

When **Password Status** is **Locked**, type the password and press <Enter> when prompted at reboot.

If an incorrect system password is entered, the system displays a message and prompts you to re-enter your password. You have three attempts to enter the correct password. After the third unsuccessful attempt, the system displays an error message that the system has halted and must be powered down.

Even after you shut down and restart the system, the error message is displayed until the correct password is entered.

 **NOTE:** You can use the **Password Status** option in conjunction with the **System Password** and **Setup Password** options to protect your system from unauthorized changes.

### Operating With A Setup Password Enabled

If **Setup Password** is **Enabled**, enter the correct setup password before modifying most of the System Setup options.

If you do not enter the correct password in three attempts, the system displays the message  
Invalid Password! Number of unsuccessful password attempts: <x> System Halted!  
Must power down.

Even after you shut down and restart the system, the error message is displayed until the correct password is entered. The following options are exceptions:

- If **System Password** is not **Enabled** and is not locked through the **Password Status** option, you can assign a system password.
- You cannot disable or change an existing system password.

 **NOTE:** You can use the Password Status option in conjunction with the **Setup Password** option to protect the system password from unauthorized changes.

## Entering The UEFI Boot Manager

 **NOTE:** Operating systems must be 64-bit UEFI-compatible (for example, Microsoft Windows Server 2012) to be installed from the UEFI boot mode. DOS and 32-bit operating systems can only be installed from the BIOS boot mode.

The Boot Manager enables you to:

- Add, delete, and arrange boot options.
- Access System Setup and BIOS-level boot options without restarting.

To enter the Boot Manager:

1. Turn on or restart your system.
2. Press **<F11>** after you see the following message:

<F11> = UEFI Boot Manager

If your operating system begins to load before you press **<F11>**, allow the system to finish booting, and then restart your system and try again.

## Using The Boot Manager Navigation Keys

Keystroke	Description
Up arrow	Moves to the previous field.
Down arrow	Moves to the next field.
<Enter>	Allows you to type in a value in the selected field (if applicable) or follow the link in the field.
Spacebar	Expands or collapses a drop-down list, if applicable.
<Tab>	Moves to the next focus area.
	 <b>NOTE:</b> For the standard graphics browser only.
<Esc>	Moves to the previous page till you view the main screen. Pressing <Esc> in the main screen exits the Boot Manager and proceeds with system boot.
<F1>	Displays the System Setup help file.



 **NOTE:** For most of the options, any changes that you make are recorded but do not take effect until you restart the system.

## Boot Manager Screen

Menu Item	Description
<b>Continue Normal Boot</b>	The system attempts to boot to devices starting with the first item in the boot order. If the boot attempt fails, the system continues with the next item in the boot order until the boot is successful or no more boot options are found.
<b>BIOS Boot Menu</b>	Displays the list of available BIOS boot options (marked with asterisks). Select the boot option you wish to use and press <Enter>.
<b>UEFI Boot Menu</b>	Displays the list of available UEFI boot options (marked with asterisks). Select the boot option you wish to use and press <Enter>. The UEFI Boot Menu enables you to <b>Add Boot Option</b> , <b>Delete Boot Option</b> , or <b>Boot From File</b> .
<b>Driver Health Menu</b>	Displays a list of the drivers installed on the system and their health status.
<b>Launch System Setup</b>	Enables you to access the System Setup.
<b>System Utilities</b>	Enables you to run the Dell Diagnostics program, and reboot the system.

## UEFI Boot Menu

Menu Item	Description
<b>Select UEFI Boot Option</b>	Displays the list of available UEFI boot options (marked with asterisks), select the boot option you wish to use and press <Enter>.
<b>Add Boot Option</b>	Adds a new boot option.
<b>Delete Boot Option</b>	Deletes an existing boot option.
<b>Boot From File</b>	Sets a one-time boot option not included in the boot option list.

## Embedded System Management

The Dell Lifecycle Controller provides advanced embedded systems management throughout the server's lifecycle. The Lifecycle Controller can be started during the boot sequence and can function independently of the operating system.

 **NOTE:** Certain platform configurations may not support the full set of features provided by the Lifecycle Controller.

For more information about setting up the Lifecycle Controller, configuring hardware and firmware, and deploying the operating system, see the Lifecycle Controller documentation at [dell.com/esmmanuals](http://dell.com/esmmanuals).

## iDRAC Settings Utility

The iDRAC Settings Utility is an interface to setup and configure the iDRAC parameters using UEFI. You can enable or disable various iDRAC parameters using the iDRAC Settings Utility.

 **NOTE:** Accessing some of the features on the iDRAC Settings Utility requires the iDRAC7 Enterprise License upgrade.

For more information on using iDRAC, see the iDRAC7 User's Guide at [dell.com/esmmanuals](http://dell.com/esmmanuals).

### Entering The iDRAC Settings Utility

1. Turn on or restart the managed system.
2. Press <F2> during Power-on Self-test (POST).
3. In the System Setup Main Menu page, click **iDRAC Settings**.  
The iDRAC Settings screen is displayed.

### Changing The Thermal Settings

The **iDRAC Settings Utility** enables you to select and customize the thermal control settings for your system.

1. Enter the iDRAC Settings utility.
2. Under **iDRAC Settings** → **Thermal** → **User Option**, select between the following options:
  - Cooling Options
  - Fan Speed Offset

 **NOTE:** When the **User Option** is set to the default **Auto** setting, the user option cannot be modified.

3. Set the **Fan Speed Offset** field.
4. Click **Back** → **Finish** → **Yes**.

# Installing System Components

## Recommended Tools

You may need the following items to perform the procedures in this section:

- Key to the system keylock
- #2 Phillips screwdriver
- Wrist grounding strap connected to ground

## Front Bezel (Optional)

### Installing The Front Bezel

1. Hook the right end of the bezel onto the chassis.
2. Fit the free end of the bezel onto the chassis.
3. Secure the bezel with the keylock.

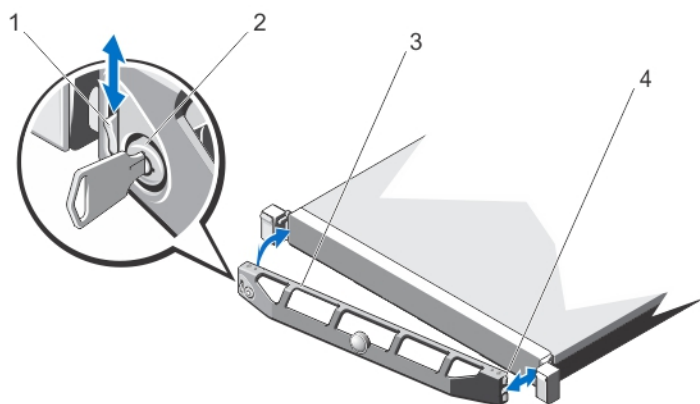

**Figure 4. Installing and Removing the Front Bezel**

- |                  |                 |
|------------------|-----------------|
| 1. release latch | 2. keylock      |
| 3. front bezel   | 4. locking hook |

### Removing The Front Bezel

1. Unlock the keylock at the left end of the bezel.
2. Lift the release latch next to the keylock.
3. Rotate the left end of the bezel away from the front panel.
4. Unhook the right end of the bezel and pull the bezel away from the system.

## Opening And Closing The System

**⚠ WARNING:** Opening the system or removing the system cover when the system is on may expose you to a risk of electric shock.

**⚠ CAUTION:** Many repairs may only be done by a certified service technician. You should only perform troubleshooting and simple repairs as authorized in your product documentation, or as directed by the online or telephone service and support team. Damage due to servicing that is not authorized by Dell is not covered by your warranty. Read and follow the safety instructions that came with the product.

**⚠ CAUTION:** Do not operate the system without the cover for a duration exceeding five minutes.

**⚠ CAUTION:** Always use a static mat and static strap while working on components in the interior of the system.

### Opening The System

1. Turn off the system and attached peripherals, and disconnect the system from the electrical outlet.
2. Rotate the latch release lock counter clockwise to the unlocked position.
3. Hold the cover on both sides, pressing your thumbs on the latch release lock and the indent, slide the cover toward the back of the system.
4. Lift the cover away from the system.

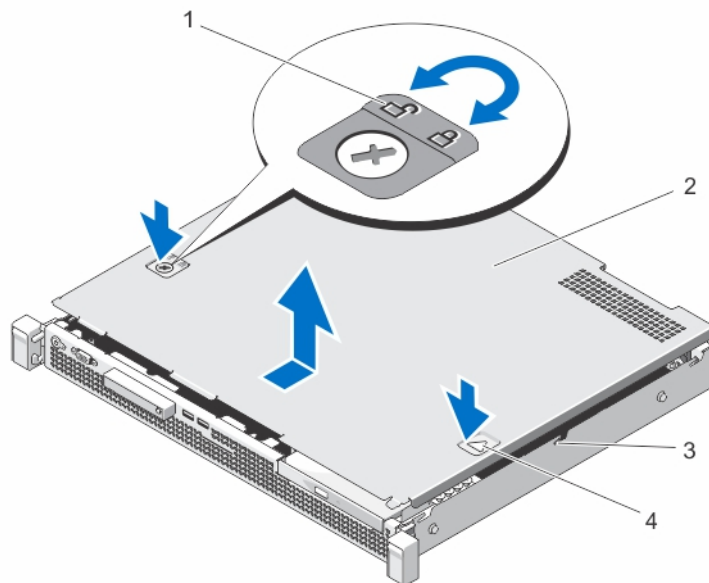

**Figure 5. Opening and Closing the System**

- |                       |                 |
|-----------------------|-----------------|
| 1. latch release lock | 2. system cover |
| 3. notches (6)        | 4. indent       |

## Closing The System

1. Place the cover onto the chassis and offset it slightly toward the back of the system so that it aligns with the notches and lays flush on the chassis.
2. Slide the cover toward the front of the chassis until it locks in position.
3. Rotate the latch release lock in a clockwise direction to secure the cover.
4. Reconnect the system to the electrical outlet and turn the system on, including any attached peripherals.

## Inside The System

**⚠ CAUTION:** Many repairs may only be done by a certified service technician. You should only perform troubleshooting and simple repairs as authorized in your product documentation, or as directed by the online or telephone service and support team. Damage due to servicing that is not authorized by Dell is not covered by your warranty. Read and follow the safety instructions that came with the product.

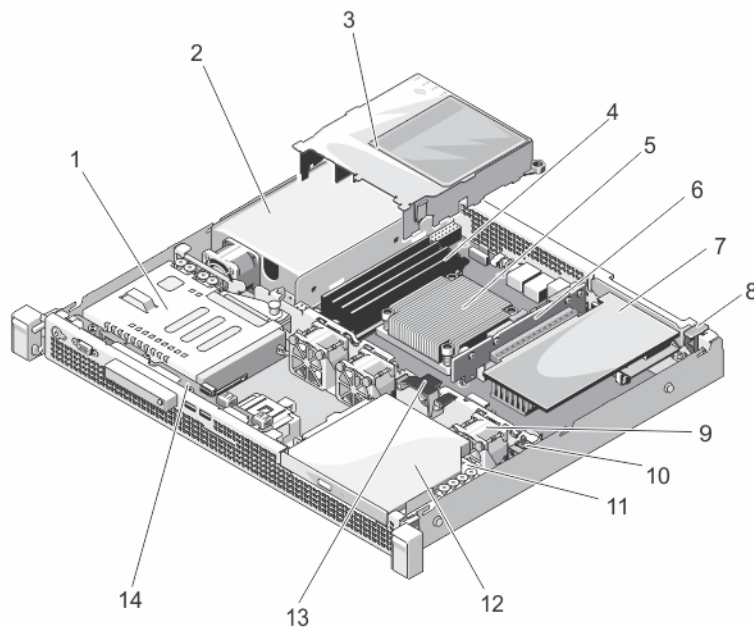

**Figure 6. Inside the System**

- |     |  |     |                          |
|-----|--|-----|--------------------------|
| 1.  | 2.5 inch (HDD0/1) or 3.5 inch (HDD0) hard-drive cage | 2.  | power supply             |
| 3.  | cooling shroud                                       | 4.  | DIMMs (4)                |
| 5.  | processor heat sink                                  | 6.  | expansion-card riser     |
| 7.  | expansion card                                       | 8.  | expansion-card latch     |
| 9.  | cooling fans (3)                                     | 10. | chassis intrusion switch |
| 11. | 3.5-inch HDD1 hard-drive cage                        | 12. | optical drive            |
| 13. | cable-routing latch                                  | 14. | control-panel board      |

**NOTE:** To install a 3.5-inch hard drive, install a 3.5 inch HDD0 hard-drive cage and to install a 2.5-inch hard drive, install a 2.5 inch HDD0/1 hard-drive cage.

## Chassis Intrusion Switch

The chassis intrusion switch detects any unauthorized access into the interior of your system and provides an indication of the same. This switch is activated as soon as the system cover is removed and access is made to the interior of your system.

### Removing The Chassis Intrusion Switch

**CAUTION:** Many repairs may only be done by a certified service technician. You should only perform troubleshooting and simple repairs as authorized in your product documentation, or as directed by the online or telephone service and support team. Damage due to servicing that is not authorized by Dell is not covered by your warranty. Read and follow the safety instructions that came with the product.

1. Turn off the system, including any attached peripherals, and disconnect the system from the electrical outlet and peripherals.
2. Open the system.
3. Disconnect the chassis intrusion switch cable from the system board.
4. Unwind the wire from the cable-routing hook.
5. Slide the chassis intrusion switch out of the chassis intrusion switch slot and lift it away from the chassis.

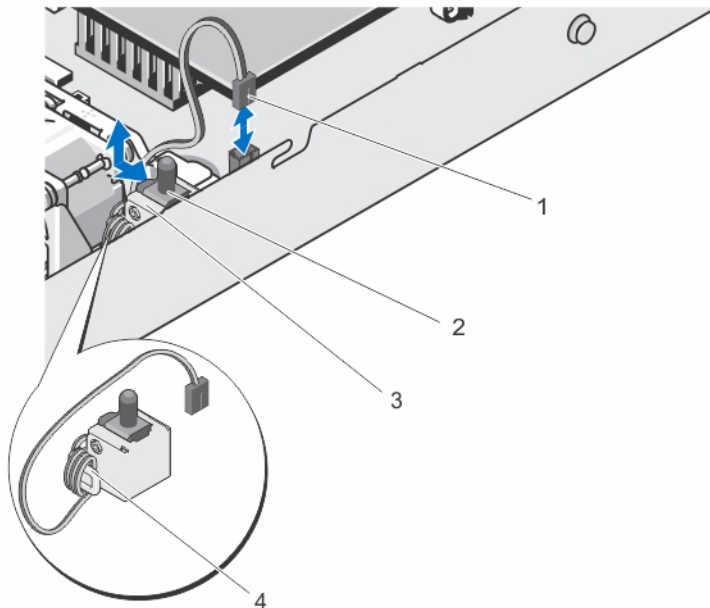

**Figure 7. Removing and Installing the Chassis Intrusion Switch**

- |                                   |                             |
|-----------------------------------|-----------------------------|
| 1. chassis intrusion switch cable | 2. chassis intrusion switch |
| 3. chassis intrusion switch slot  | 4. cable-routing hook       |

## Installing The Chassis Intrusion Switch

 **CAUTION:** Many repairs may only be done by a certified service technician. You should only perform troubleshooting and simple repairs as authorized in your product documentation, or as directed by the online or telephone service and support team. Damage due to servicing that is not authorized by Dell is not covered by your warranty. Read and follow the safety instructions that came with the product.

1. Turn off the system, including any attached peripherals, and disconnect the system from the electrical outlet and peripherals.
2. Open the system.
3. Insert the chassis intrusion switch into the chassis intrusion switch slot and slide it in to secure it.
4. Wind the chassis intrusion switch cable around the cable-routing hook.
5. Connect the chassis intrusion switch cable to the system board.
6. Close the system.

## Optical Drive (Optional)

### Removing The Optical Drive

 **CAUTION:** Many repairs may only be done by a certified service technician. You should only perform troubleshooting and simple repairs as authorized in your product documentation, or as directed by the online or telephone service and support team. Damage due to servicing that is not authorized by Dell is not covered by your warranty. Read and follow the safety instructions that came with the product.

1. If installed, remove the front bezel.
2. Turn off the system, including any attached peripherals, and disconnect the system from the electrical outlet and peripherals.
3. Open the system.
4. Disconnect the power and data cables from the back of the optical drive.  
Note the routing of the power and data cables as you remove them from the system board and the optical drive. You must route these cables properly when you replace them to prevent them from being pinched or crimped.
5. Press the release latch. Lift and orient the drive to release it from the metal standoffs.  
If you are not installing a new optical drive, install the optical-drive blank.
6. To install the optical-drive blank, slide the optical-drive blank into the optical-drive slot until it clicks into place.
7. Close the system.
8. Reconnect the system to the electrical outlet and turn the system on, including any attached peripherals.

9. If applicable, install the front bezel.

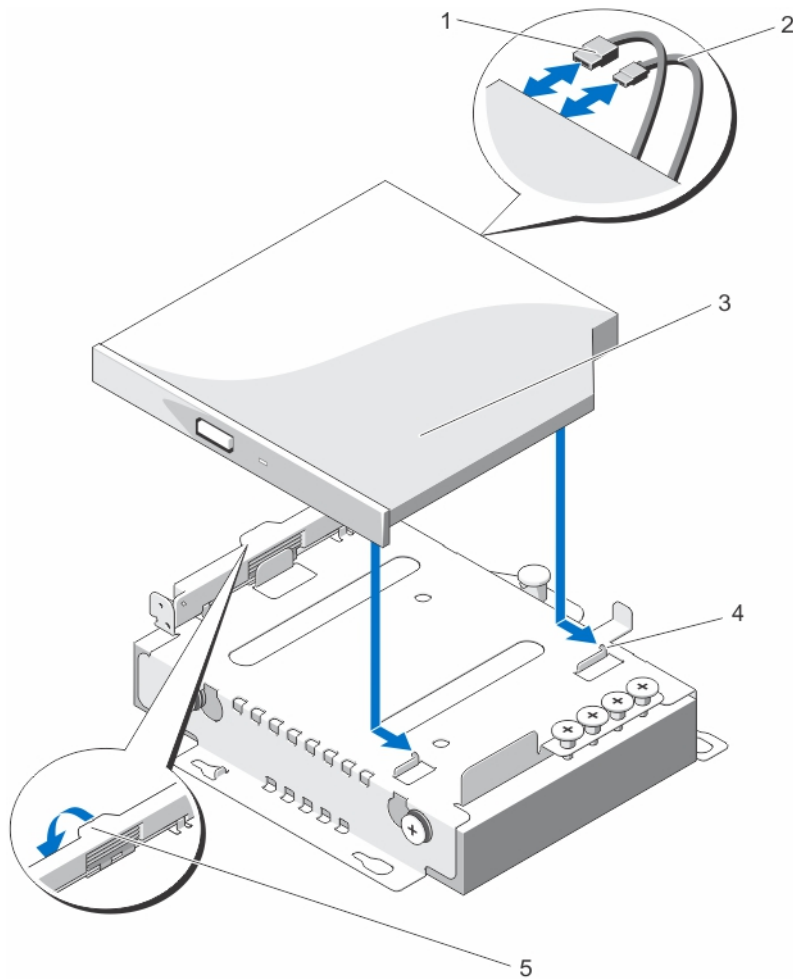

**Figure 8. Removing and Installing the Optical Drive**



- |                  |                        |
|------------------|------------------------|
| 1. data cable    | 2. power cable         |
| 3. optical drive | 4. metal standoffs (2) |
| 5. release latch |                        |

## Installing The Optical Drive

**⚠ CAUTION:** Many repairs may only be done by a certified service technician. You should only perform troubleshooting and simple repairs as authorized in your product documentation, or as directed by the online or telephone service and support team. Damage due to servicing that is not authorized by Dell is not covered by your warranty. Read and follow the safety instructions that came with the product.

1. If installed, remove the front bezel.
2. Turn off the system, including any attached peripherals, and disconnect the system from the electrical outlet.
3. Open the system.  
Remove the optical-drive blank, if applicable.



4. To remove the optical-drive blank, pull the optical-drive blank away from the system.
5. Press down on the release latch and place the optical drive in position.
6. Align the slots on the side of the optical drive with the metal standoffs.
7. Slide the optical drive onto the chassis until it is seated firmly.
  -  **NOTE:** Make sure that the slots on the optical drive lock into the metal standoffs on the chassis.
8. Push the release latch back into position.
9. Connect the power cable.
10. Connect the data cable to the optical drive and to the SATA connector on the system board.
  -  **NOTE:** Route and secure the cables using the cable-routing latch on the chassis to prevent them from being pinched or crimped.
11. Close the system.
12. If applicable, install the front bezel.
13. Reconnect the system to the electrical outlet and turn the system on, including any attached peripherals.

## Hard Drives

Your system supports Entry Hard Drives and Enterprise Class Hard Drives. Entry Hard Drives are designed for 5x8 operating environment with less workload rating to drives and Enterprise Class Drives are designed for 24x7 operating environment. Selecting the correct drive class will enable the critical areas of quality, functionality, performance, and reliability to be optimized for the target implementation.

 **NOTE:** Do not mix Enterprise Class Drives with Entry Hard Drives.

Choosing the right drive type depends on the usage pattern. Improper use of Entry Hard Drives (workload rating exceed 55TB/year) will lead to significant risk and increase the drives failure rate.

For more information on these hard drives, see the *512e and 4Kn Disk Formats* whitepaper and *4K Sector HDD FAQ* document at [dell.com/poweredgemanuals](http://dell.com/poweredgemanuals).

Depending on the configuration, your system supports one of the following:

- Up to two 3.5 inch SAS, SATA, or Nearline SAS hard drives
- Up to two 2.5 inch SAS, SATA, or Nearline SAS hard drives

### Removing A 3.5 Inch Hard-Drive Cage

 **CAUTION:** Many repairs may only be done by a certified service technician. You should only perform troubleshooting and simple repairs as authorized in your product documentation, or as directed by the online or telephone service and support team. Damage due to servicing that is not authorized by Dell is not covered by your warranty. Read and follow the safety instructions that came with the product.

 **NOTE:** Your system supports two 3.5-inch hard-drive cages, HDD0 and HDD1. You can install both, the optical drive and a 3.5-inch hard drive in the HDD1 cage. You can only install a 3.5-inch hard drive in the HDD0 cage. The HDD0 and HDD1 cages cannot be used interchangeably. For more information, see [Inside The System](#).

**NOTE:** The procedure for removing a 3.5 inch HDD0 and HDD1 cage is identical.

1. If installed, remove the front bezel.
2. Turn off the system and attached peripherals, and disconnect the system from the electrical outlet and from the peripherals.
3. Open the system.
4. Disconnect the power and data cables from the hard drive.

**NOTE:** If you have installed a PowerEdge RAID Controller (PERC) card, the power and data cables are connected to the PERC card cable adapter. To disconnect the power and data cables, remove the PERC card cable adapter from the hard drive.

5. If applicable, remove the optical drive installed on top of the hard-drive cage (HDD1).  
For more information on removing the optical drive, see [Removing The Optical Drive](#).
6. Pull the release pin, slide the hard-drive cage away from the chassis wall.
7. Lift the hard-drive cage away from the chassis.

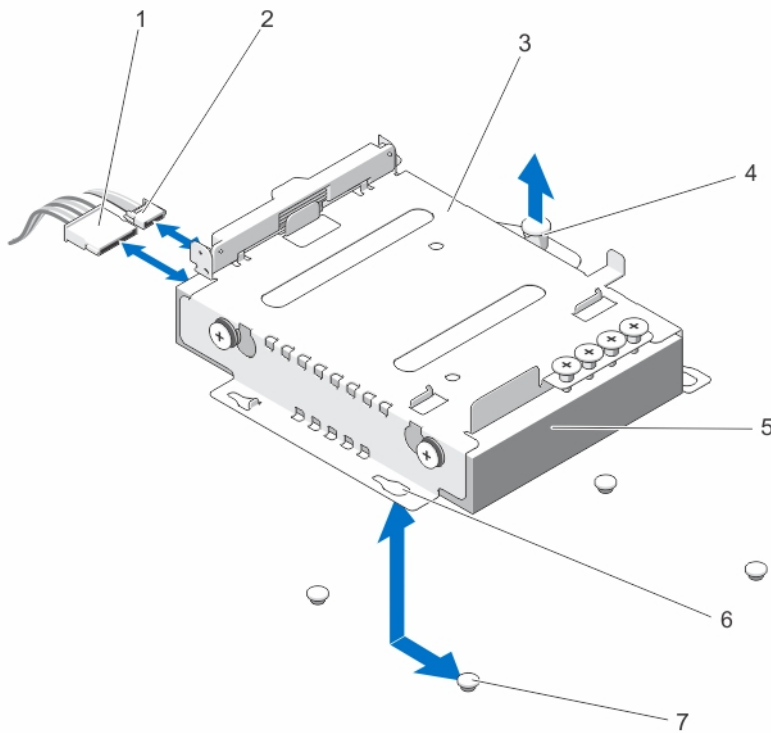



**Figure 9. Removing and Installing a 3.5-Inch Hard-Drive (HDD1) Cage**

- |                    |                |
|--------------------|----------------|
| 1. power cable     | 2. SATA cable  |
| 3. hard-drive cage | 4. release pin |
| 5. hard drive      | 6. slots (4)   |
| 7. standoffs (4)   |                |

## Installing A 3.5 Inch Hard-Drive Cage

 **CAUTION:** Many repairs may only be done by a certified service technician. You should only perform troubleshooting and simple repairs as authorized in your product documentation, or as directed by the online or telephone service and support team. Damage due to servicing that is not authorized by Dell is not covered by your warranty. Read and follow the safety instructions that came with the product.

 **NOTE:** Your system supports two 3.5-inch hard-drive cages, HDD0 and HDD1. You can install both the optical drive and a 3.5-inch hard drive in the HDD1 cage. You can only install a 3.5-inch hard drive in the HDD0 cage. The HDD0 and HDD1 cages cannot be used interchangeably. For more information, see [Inside The System](#).

 **NOTE:** The procedure to install a 3.5 inch HDD0 and HDD1 cage is identical.

1. If installed, remove the front bezel.
2. Turn off the system and attached peripherals, and disconnect the system from the electrical outlet and from the peripherals.
3. Open the system.
4. Align the slots on the hard-drive cage with the standoffs on the chassis. Slide the hard-drive cage toward the chassis wall until it snaps into place.

 **NOTE:** For the 3.5 inch HDD0 cage, the slots are under the hard-drive cage.

5. Connect the power and data cables to the hard drive.
  - If connecting to the integrated SATA controller (SATA hard drives only), connect the SATA data cable to the SATA connector on the system board.
  - If connecting to a SAS RAID controller card (SAS or SATA hard drives), connect the data cable to the connector on the card edge.
  - If you have installed a PERC card, connect the power and data cables to the PERC card cable adapter. Connect the PERC card cable adapter to the hard drive.
6. Close the system.
7. Reconnect the system to the electrical outlet and turn on the system and attached peripherals.
8. Enter the System Setup and ensure that the hard drive's controller is enabled.
9. Exit the System Setup and restart the system.
10. Install any software required for the hard drive operation as described in the documentation for the hard drive.

## Removing A 3.5 Inch Hard Drive From The Hard-Drive Cage

**△ CAUTION:** Many repairs may only be done by a certified service technician. You should only perform troubleshooting and simple repairs as authorized in your product documentation, or as directed by the online or telephone service and support team. Damage due to servicing that is not authorized by Dell is not covered by your warranty. Read and follow the safety instructions that came with the product.

1. Remove the screws from the side of the 3.5 inch hard-drive cage.
2. Remove the hard drive from the hard-drive cage.

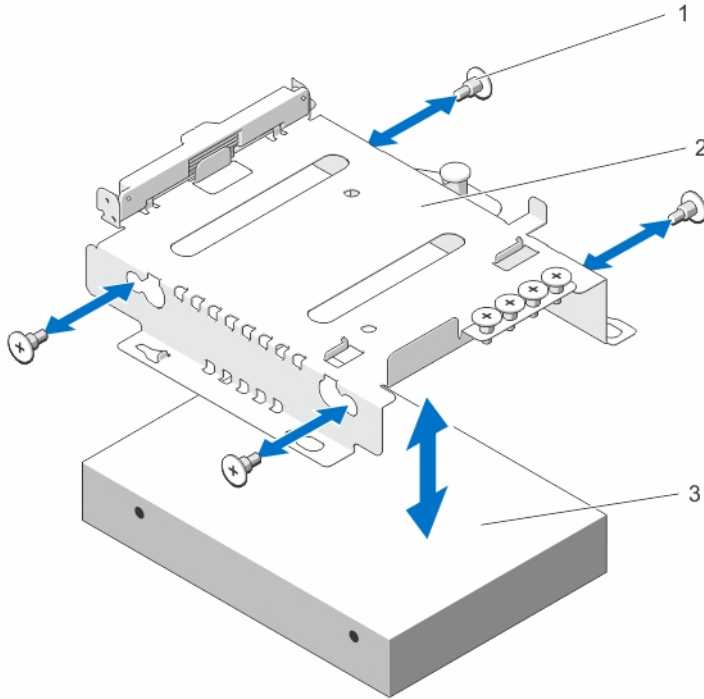

Figure 10. Removing and Installing a 3.5 Inch Hard Drive Into the Hard-Drive Cage

- |                        |                             |
|------------------------|-----------------------------|
| 1. screws (4)          | 2. 3.5 inch hard-drive cage |
| 3. 3.5 inch hard drive |                             |

## Installing A 3.5 Inch Hard Drive Into The Hard-Drive Cage

**△ CAUTION:** Many repairs may only be done by a certified service technician. You should only perform troubleshooting and simple repairs as authorized in your product documentation, or as directed by the online or telephone service and support team. Damage due to servicing that is not authorized by Dell is not covered by your warranty. Read and follow the safety instructions that came with the product.

1. Insert the hard drive into the hard-drive cage.
2. Align the screw holes on the hard drive with the screw holes on the hard-drive cage.
3. Install the screws to secure the hard drive to the hard-drive cage.

## Removing A 2.5 Inch Hard-Drive Cage

**CAUTION:** Many repairs may only be done by a certified service technician. You should only perform troubleshooting and simple repairs as authorized in your product documentation, or as directed by the online or telephone service and support team. Damage due to servicing that is not authorized by Dell is not covered by your warranty. Read and follow the safety instructions that came with the product.

1. If installed, remove the front bezel.
2. Turn off the system and attached peripherals, and disconnect the system from the electrical outlet and from the peripherals.
3. Open the system.
4. Disconnect the data and power cables from the hard drive.

**NOTE:** If you have installed a PERC card, the power and data cables are connected to the PERC card cable adapter. To disconnect the power and data cables remove the PERC card cable adapter from the hard drive.

5. Pull the release pin on the hard-drive cage, slide the hard-drive cage, and lift it away from the chassis.

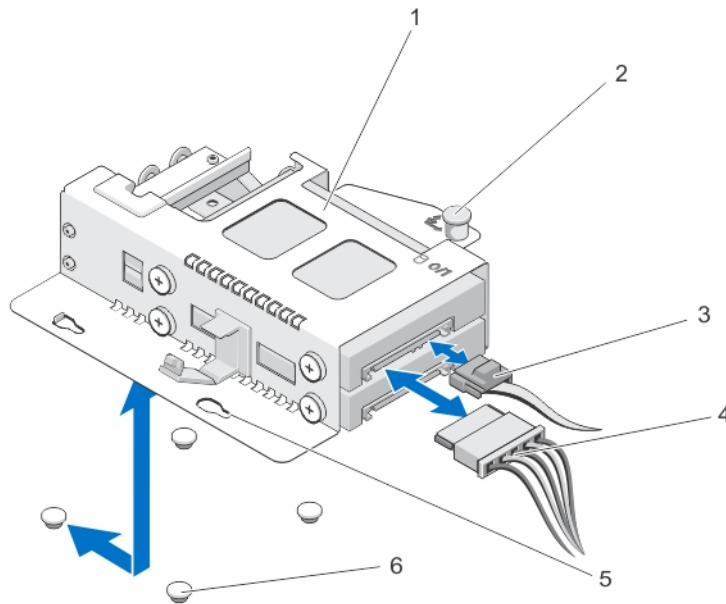

**Figure 11. Removing and Installing a 2.5 Inch Hard-Drive Cage**

- |                    |                  |
|--------------------|------------------|
| 1. hard-drive cage | 2. release pin   |
| 3. data cable      | 4. power cable   |
| 5. slots (4)       | 6. standoffs (4) |

## Installing A 2.5 Inch Hard-Drive Cage

 **CAUTION:** Many repairs may only be done by a certified service technician. You should only perform troubleshooting and simple repairs as authorized in your product documentation, or as directed by the online or telephone service and support team. Damage due to servicing that is not authorized by Dell is not covered by your warranty. Read and follow the safety instructions that came with the product.

1. If installed, remove the front bezel.
2. Turn off the system and attached peripherals, and disconnect the system from the electrical outlet and from the peripherals.
3. Open the system.
4. Align the slots under the hard-drive cage with the standoffs on the chassis. Slide the hard-drive cage until it snaps into place.
5. Connect the power and data cables to the hard drive.
  - If you are connecting to the integrated SATA controller (SATA hard drives only), connect the SATA data cable to the SATA connector on the system board.
  - If you are connecting to a SAS RAID controller card (SAS or SATA hard drives), connect the data cable to the connector on the card edge.
  - If you have installed a PERC card, connect the power and data cables to the PERC card cable adapter. Connect the PERC card cable adapter to the hard drive.
6. Close the system.
7. Reconnect the system to the electrical outlet and turn on the system and attached peripherals.
8. Enter the System Setup and ensure that the hard drive's controller is enabled.
9. Exit the System Setup and restart the system.
10. Install any software required for the hard drive operation as described in the documentation for the hard drive.

## Removing A 2.5 Inch Hard Drive From The Hard-Drive Cage

1. Remove the screws from the side of the hard-drive cage.
2. Remove the hard drive from the hard-drive cage.

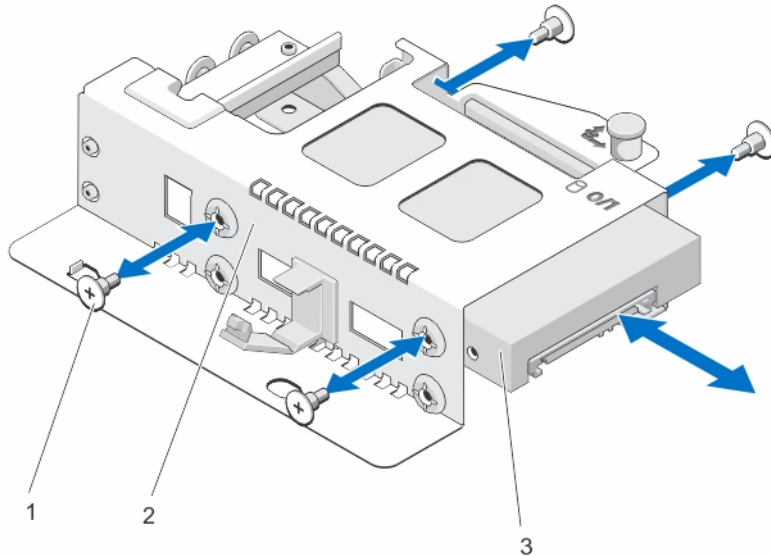

Figure 12. Removing and Installing a 2.5 Inch Hard Drive Into the Hard-Drive Cage

1. screws (4)
2. 2.5 inch hard-drive cage
3. 2.5 inch hard drive

## Installing A 2.5 Inch Hard Drive Into The Hard-Drive Cage

**⚠ CAUTION:** Many repairs may only be done by a certified service technician. You should only perform troubleshooting and simple repairs as authorized in your product documentation, or as directed by the online or telephone service and support team. Damage due to servicing that is not authorized by Dell is not covered by your warranty. Read and follow the safety instructions that came with the product.

1. Align the screw holes on the hard drive with the screw holes on the hard-drive cage.
2. Install the screws to secure the hard drive to the hard-drive cage.

# LED Module

## Removing The LED Module

**⚠ CAUTION:** Many repairs may only be done by a certified service technician. You should only perform troubleshooting and simple repairs as authorized in your product documentation, or as directed by the online or telephone service and support team. Damage due to servicing that is not authorized by Dell is not covered by your warranty. Read and follow the safety instructions that came with the product.

1. Turn off the system, including any attached peripherals.
2. Disconnect the power cable from the power source.
3. Remove the bezel, if applicable.
4. Insert a screw driver into the notch and pull out the LED label.

**🔩 NOTE:** Retain the removed LED label for future use.

5. Remove the screws securing the LED module to the chassis.
6. Remove the LED module from the chassis.

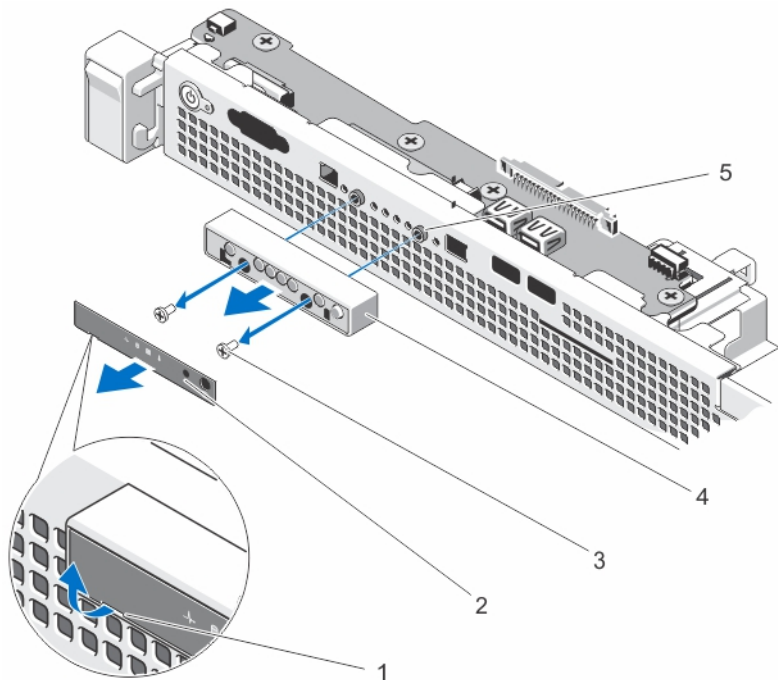

**Figure 13. Removing and Installing the LED Module**

- |                  |               |
|------------------|---------------|
| 1. notch         | 2. LED label  |
| 3. screws (2)    | 4. LED module |
| 5. standoffs (2) |               |



## Installing The LED Module

 **CAUTION:** Many repairs may only be done by a certified service technician. You should only perform troubleshooting and simple repairs as authorized in your product documentation, or as directed by the online or telephone service and support team. Damage due to servicing that is not authorized by Dell is not covered by your warranty. Read and follow the safety instructions that came with the product.

1. Turn off the system, including any attached peripherals.
2. Disconnect the power cable from the power source.
3. Remove the bezel, if applicable.
4. Align the LED module with the standoffs on the chassis.
5. Install the screws to secure the LED module to the chassis.
6. Paste the LED label on the LED Module.

## Control-Panel Board

### Removing The Control-Panel Board

 **CAUTION:** Many repairs may only be done by a certified service technician. You should only perform troubleshooting and simple repairs as authorized in your product documentation, or as directed by the online or telephone service and support team. Damage due to servicing that is not authorized by Dell is not covered by your warranty. Read and follow the safety instructions that came with the product.

1. If installed, remove the front bezel.
2. Turn off the system, including any attached peripherals, and disconnect the system from the electrical outlet and peripherals.
3. Open the system.
4. Remove the 3.5 inch hard-drive cage, if applicable.
5. Disconnect the control-panel cable at the back of the control-panel board:

 **CAUTION:** Do not pull on the cable to unseat the connector. Doing so can damage the cable.

- a) Press the metal tabs on the ends of the cable connector.
  - b) Gently work the connector out of the socket.
6. Remove all the cables connecting the control-panel board to the chassis.
  7. Remove the screw(s) securing the control-panel board to the chassis.

- Slide the control-panel board toward the back of the system and lift it out of the chassis.

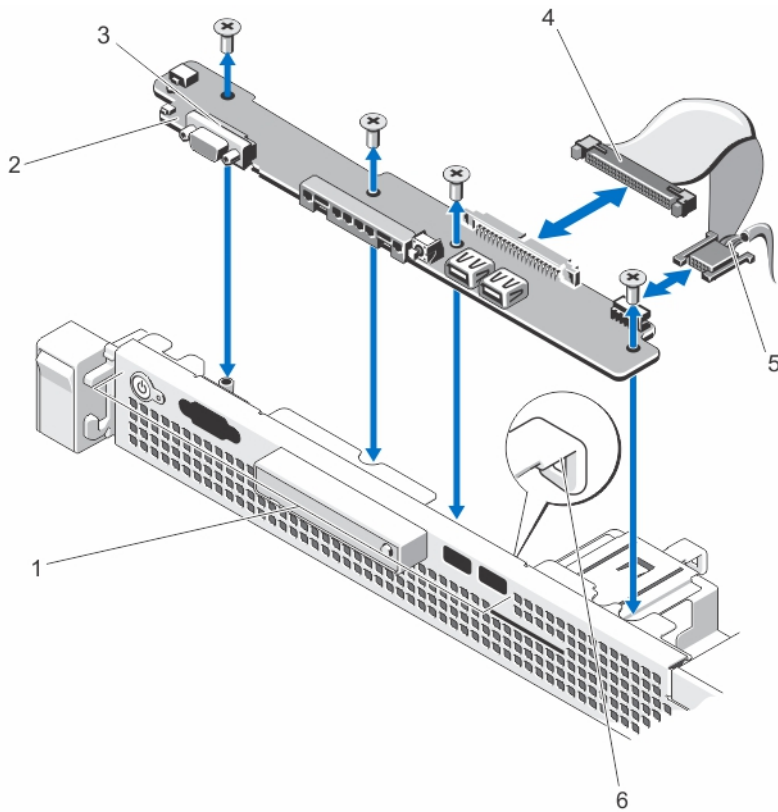

Figure 14. Removing and Installing the Control-Panel Board

- |                                   |  |
|-----------------------------------|--|
| 1. control-panel                  | 2. control-panel board                 |
| 3. control-panel board screws (4) | 4. control-panel board connector cable |
| 5. USB connector                  | 6. cable-routing hook                  |

## Installing The Control-Panel Board

**CAUTION:** Many repairs may only be done by a certified service technician. You should only perform troubleshooting and simple repairs as authorized in your product documentation, or as directed by the online or telephone service and support team. Damage due to servicing that is not authorized by Dell is not covered by your warranty. Read and follow the safety instructions that came with the product.

- Insert the control-panel module into the slot in the chassis and align the two screw holes on the control-panel module with the corresponding holes on the chassis.
- Secure the control-panel board with the screws.
- Connect all the applicable cables to the control-panel board.



**NOTE:** Ensure that the cables inside the system are routed through the cable-routing hook.

- Install the 3.5 inch hard-drive cage, if applicable.
- Close the system.
- Reconnect the system and peripherals to their power sources, and turn them on.





7. If applicable, install the front bezel.

## Cooling Fans

Your system supports three cooling fans.

-  **NOTE:** Install fan 3 if you are installing an expansion card.
-  **NOTE:** In the event of a problem with a particular fan, the fan number is referenced by the system's management software, allowing you to easily identify and replace the proper fan by noting the fan numbers on the fan bracket.

### Removing A Cooling Fan

-  **WARNING:** Opening the system or removing the system cover when the system is on may expose you to a risk of electric shock. Exercise utmost care while removing or installing cooling fans.
  -  **CAUTION:** Many repairs may only be done by a certified service technician. You should only perform troubleshooting and simple repairs as authorized in your product documentation, or as directed by the online or telephone service and support team. Damage due to servicing that is not authorized by Dell is not covered by your warranty. Read and follow the safety instructions that came with the product.
  -  **CAUTION:** Do not operate the system with the cover removed for a duration exceeding five minutes.
  -  **NOTE:** The procedure for removing each fan is identical.
1. Turn off the system, including any attached peripherals, and disconnect the system from the electrical outlet.
  2. Open the system.
  3. Remove the cooling shroud.
  4. Disconnect the fan power cable from the power cable connector on the system board.
  5. Lift the fan out of the cooling-fan bracket.
    -  **NOTE:** When you remove fan 3, ensure that you install the fan Mylar in the fan socket to prevent thermal air re-circulation.

6. Install the cooling shroud.

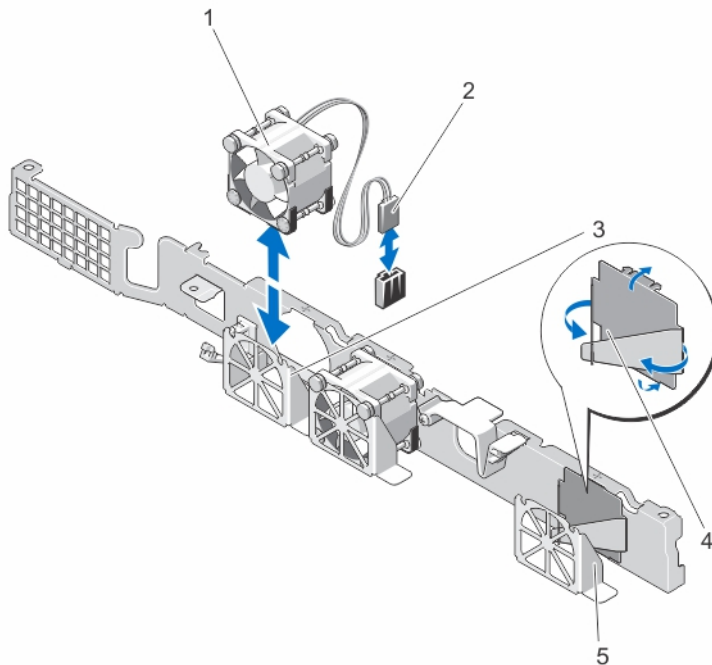

Figure 15. Removing and Installing a Cooling Fan

- |                        |                              |
|------------------------|------------------------------|
| 1. cooling fans (3)    | 2. fan power cable connector |
| 3. cooling-fan bracket | 4. fan Mylar                 |
| 5. fan 3 bracket       |                              |

## Installing A Cooling Fan

**CAUTION:** Many repairs may only be done by a certified service technician. You should only perform troubleshooting and simple repairs as authorized in your product documentation, or as directed by the online or telephone service and support team. Damage due to servicing that is not authorized by Dell is not covered by your warranty. Read and follow the safety instructions that came with the product.

1. Turn off the system, including any attached peripherals, and disconnect the system from the electrical outlet.
2. Open the system.
3. Remove the cooling shroud.
4. Orient the fan module so that the side with the power cable faces the back of the system.
  - NOTE:** Install fan 3 if you are installing an expansion card. Remove the fan Mylar from the fan 3 slot and install fan 3. Retain the removed fan Mylar for future use.
5. Lower the fan into the cooling-fan bracket.
  - NOTE:** When aligned correctly, the fan cable is on the right of the fan.
6. Connect the fan power cable to the power cable connector on the system board.
7. Replace the cooling shroud.
8. Close the system.

9. Reconnect the system to the electrical outlet and turn the system on, including any attached peripherals.

## Cooling Shroud

### Removing The Cooling Shroud

**CAUTION:** Many repairs may only be done by a certified service technician. You should only perform troubleshooting and simple repairs as authorized in your product documentation, or as directed by the online or telephone service and support team. Damage due to servicing that is not authorized by Dell is not covered by your warranty. Read and follow the safety instructions that came with the product.

**CAUTION:** Never operate your system without the cooling shroud. The system may get overheated, which may result in loss of performance.

1. Turn off the system, including any attached peripherals, and disconnect the system from the electrical outlet and peripherals.
2. Open the system.
3. Hold the touch points and lift the cooling shroud away from the system.

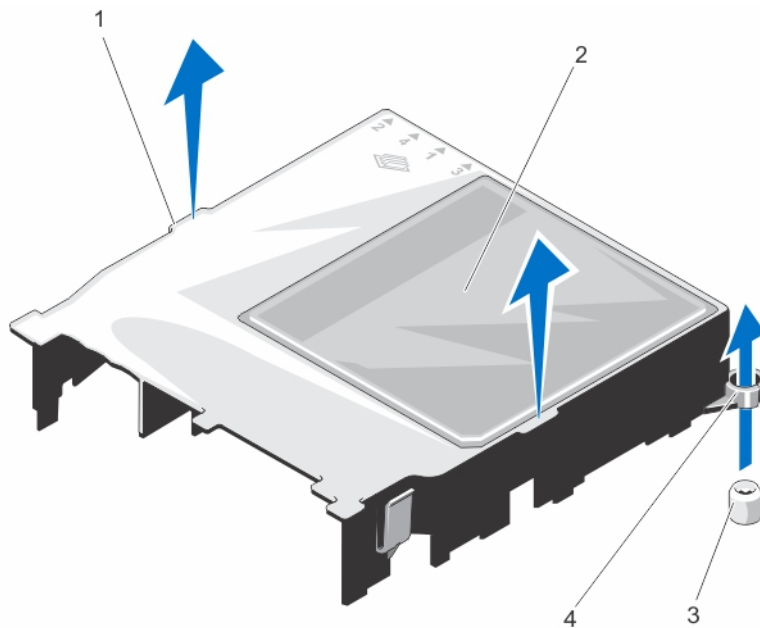

**Figure 16. Removing and Installing the Cooling Shroud**

- |                                    |   |
|------------------------------------|---|
| 1. cooling-shroud touch points     | 2. cooling shroud                       |
| 3. cooling-shroud guide screws (2) | 4. cooling-shroud guide screw slots (2) |

## Installing The Cooling Shroud

**CAUTION:** Many repairs may only be done by a certified service technician. You should only perform troubleshooting and simple repairs as authorized in your product documentation, or as directed by the online or telephone service and support team. Damage due to servicing that is not authorized by Dell is not covered by your warranty. Read and follow the safety instructions that came with the product.

**NOTE:** For proper seating of the cooling shroud in the chassis, ensure that the cables inside the system are routed through the cable routing latch.

1. Position the cooling shroud by aligning the cooling-shroud guide slots with the cooling-shroud guide screws on the system board.
2. Lower the cooling shroud into the chassis until all edges are secured to the system board. When firmly seated, the memory socket numbers marked on the cooling shroud align with the respective memory sockets.
3. Close the system.
4. Reconnect the system to the electrical outlet and turn the system on, including any attached peripherals.

## System Memory

Your system supports DDR3 unbuffered ECC DIMMs. It supports DDR3 and DDR3L voltage specifications.

**NOTE:** MT/s indicates DIMM speed in MegaTransfers per second.

Memory bus operating frequency can be 1600 MT/s or 1333 MT/s, depending on:

- maximum frequency of the DIMMs
- maximum supported DIMM frequency of the processor

Your system has four memory sockets organized into two channels. In each channel, the release levers of the first socket are marked white and the second socket black.

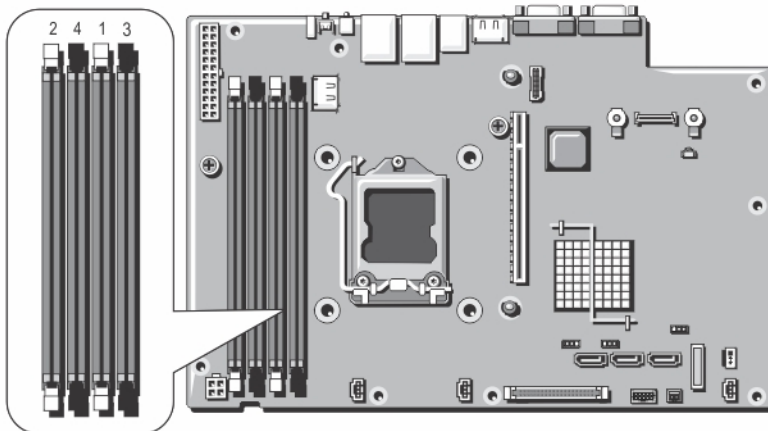

**Figure 17. Memory Socket Locations**

Memory channels are organized as follows:

channel 1: memory sockets 1 and 3

channel 2: memory sockets 2 and 4

The following table shows the memory populations and operating frequencies for the supported configurations.

DIMM Type	DIMMs Populated/ Channel	Operating Frequency (in MT/s)	Maximum DIMM Rank/ Channel
<b>1.35 V</b>			
UDIMM ECC	1	1333, 1600	Dual rank
	2	1333, 1600	Dual rank

## General Memory Module Installation Guidelines

 **NOTE:** Memory configurations that fail to observe these guidelines can prevent your system from booting, hanging during memory configuration, or operating with reduced memory.

This system supports Flexible Memory Configuration, enabling the system to be configured and run in any valid chipset architectural configuration. The following are the recommended guidelines for best performance:

- x4 and x8 DRAM based DIMMs can be mixed.
- Populate all sockets with white release tabs first, and then black.
- Populate the sockets by highest rank count in the following order – first in sockets with white release levers, and then black. For example, if you want to mix quad-rank and dual-rank DIMMs, populate quad-rank DIMMs in the sockets with white release tabs and dual-rank DIMMs in the sockets with black release tabs.
- Memory modules of different sizes can be mixed provided that other memory population rules are followed (for example, 4 GB and 8 GB memory modules can be mixed).
- If memory modules with different speeds are installed, they will operate at the speed of the slowest installed memory module(s) or slower depending on system DIMM configuration.

## Sample Memory Configurations

The following table shows sample memory configurations that follow the appropriate memory guidelines stated in this section.

 **NOTE:** Minimum supported memory is 4 GB and maximum supported memory is 32 GB.

 **NOTE:** 1R and 2R in the following table indicates single- and dual-rank DIMMs respectively.

**Table 1. Memory Configurations**

System Capacity (in GB)	DIMM Size (in GB)	Number of DIMMs	DIMM Rank, Organization, and Frequency	DIMM Slot Population
4	4	1	1R, x8, 1333 MT/s, 1R, x8, 1600 MT/s	1
8	4	2	1R, x8, 1333 MT/s, 1R, x8, 1600 MT/s	1, 2
16	4	4	2R, x4, 1333 MT/s,	1, 2, 3, 4

System Capacity (in GB)	DIMM Size (in GB)	Number of DIMMs	DIMM Rank, Organization, and Frequency	DIMM Slot Population
32	8	4	2R, x4, 1600 MT/s	1, 2, 3, 4
			2R, x4, 1333 MT/s,	
			2R, x4, 1600 MT/s	

## Removing Memory Modules

**⚠ WARNING:** The memory modules are hot to the touch for some time after the system has been powered down. Allow time for the memory modules to cool before handling them. Handle the memory modules by the card edges and avoid touching the components or metallic contacts on the memory module.

**⚠ CAUTION:** Many repairs may only be done by a certified service technician. You should only perform troubleshooting and simple repairs as authorized in your product documentation, or as directed by the online or telephone service and support team. Damage due to servicing that is not authorized by Dell is not covered by your warranty. Read and follow the safety instructions that came with the product.

1. Turn off the system, including any attached peripherals, and disconnect the system from the electrical outlet and peripherals.
2. Open the system.
3. Remove the cooling shroud.
4. Locate the appropriate memory-module socket(s).
5. To release the memory module from the socket, simultaneously press the ejectors on both ends of the memory module socket.

**⚠ CAUTION:** Handle each memory module only on the card edges, making sure not to touch the middle of the memory module or metallic contacts. To avoid damaging the memory module, handle only one memory module at a time.

6. Remove the memory module.
7. Install the cooling shroud.
8. Close the system.
9. Reconnect the system to the electrical outlet and turn the system on, including any attached peripherals.

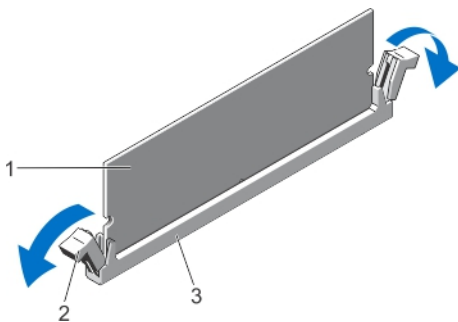



**Figure 18. Removing the Memory Module**

1. memory module
2. memory-module socket ejectors (2)
3. memory-module socket



## Installing Memory Modules

 **WARNING:** The memory modules are hot to the touch for some time after the system has been powered down. Allow time for the memory modules to cool before handling them. Handle the memory modules by the card edges and avoid touching the components or metallic contacts on the memory module.

 **CAUTION:** Many repairs may only be done by a certified service technician. You should only perform troubleshooting and simple repairs as authorized in your product documentation, or as directed by the online or telephone service and support team. Damage due to servicing that is not authorized by Dell is not covered by your warranty. Read and follow the safety instructions that came with the product.

1. Turn off the system, including any attached peripherals, and disconnect the system from the electrical outlet.
2. Open the system.
3. Remove the cooling shroud.
4. Locate the memory-module sockets.

 **CAUTION:** Handle each memory module only by the card edges, making sure not to touch the middle of the memory module or metallic contacts. To avoid damaging the memory module, handle only one memory module at a time.

5. Press the ejectors on the memory module socket down and out to allow the memory module to be inserted into the socket.
6. Align the memory-module's edge connector with the alignment key of the memory-module socket, and insert the memory module in the socket.

 **CAUTION:** To prevent damage to the memory-module socket during installation, apply pressure at both ends of the memory module evenly. Do not apply pressure to the center of the memory module.

 **NOTE:** The memory-module socket has an alignment key that allows you to install the memory module in the socket in only one orientation.

7. Press down on the memory module with your thumbs until the memory module snaps into place.
8. Repeat step 4 through step 7 of this procedure to install the remaining memory modules.
9. Replace the cooling shroud.
10. Close the system.
11. Reconnect the system to the electrical outlet and turn on the system, including any attached peripherals.
12. Press <F2> to enter the System Setup, and check the memory settings.  
The system should have already changed the value to reflect the newly installed memory.
13. If the value is incorrect, one or more of the memory modules may not be installed properly. Repeat step 4 through step 7 of this procedure, checking to ensure that the memory modules are firmly seated in their sockets.

14. Run the appropriate diagnostic test.

For more information, see [Using System Diagnostics](#).

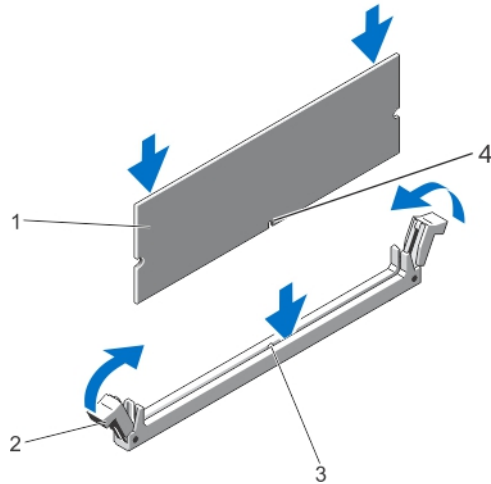

**Figure 19. Installing the Memory Module**

- |                                       |                                |
|---------------------------------------|--------------------------------|
| 1. memory module                      | 2. memory-module ejectors      |
| 3. memory-module socket alignment key | 4. memory-module alignment key |

## Internal USB Memory Key (Optional)

An optional USB memory key installed inside your system can be used as a boot device, security key, or mass storage device. The USB connector must be enabled by the **Internal USB Port** option in the **Integrated Devices** screen of the System Setup.

To boot from the USB memory key, configure the USB memory key with a boot image and then specify the USB memory key in the boot sequence in the System Setup.

 **NOTE:** The internal USB connector (INT\_USB1) is located on the system board.

### Removing And Installing The Internal USB Key

 **CAUTION:** Many repairs may only be done by a certified service technician. You should only perform troubleshooting and simple repairs as authorized in your product documentation, or as directed by the online or telephone service and support team. Damage due to servicing that is not authorized by Dell is not covered by your warranty. Read and follow the safety instructions that came with the product.

1. Turn off the system, including any attached peripherals, and disconnect the system from the electrical outlet and peripherals.
2. Open the system.
3. Locate the USB connector (INT\_USB) on the system board.
4. If installed, remove the USB key.
5. Insert the USB key into the USB connector.
6. Close the system.
7. Reconnect the system to the electrical outlet and turn the system on, including any attached peripherals.

8. Enter the System Setup and verify that the USB key is detected by the system.

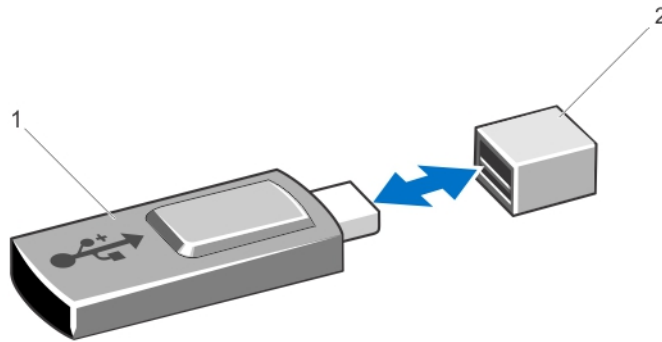

**Figure 20. Removing and Installing the Internal USB Key**

1. USB memory key
2. USB memory key connector

## Expansion Cards And Expansion-Card Risers

### Expansion Card Installation Guidelines

**NOTE:** To use an expansion card, you need to install an expansion-card riser. If your system configuration does not include the expansion-card riser, purchase a kit with the riser.

**NOTE:** If you are installing an expansion card, purchase and install fan 3.

Your system supports one of the following expansion cards:

- PCI Express Generation 3 expansion card.
- PERC H310/H710/H810

**NOTE:** When you install a PERC card, connect the data and power cables to the hard drive using a PERC card cable adapter.

### Expansion Card Types And Form Factor

The following table describes the types of expansions cards and the form factor:

**Table 2. Expansion Card Types and Form Factor**

Card Type	Form Factor
FC8 HBA	full height
SAS RAID	full height
10 Gb NICs	full height
1 Gb NICs	full height

## Removing An Expansion Card

**⚠ CAUTION:** Many repairs may only be done by a certified service technician. You should only perform troubleshooting and simple repairs as authorized in your product documentation, or as directed by the online or telephone service and support team. Damage due to servicing that is not authorized by Dell is not covered by your warranty. Read and follow the safety instructions that came with the product.

1. Turn off the system, including any attached peripherals, and disconnect the system from the electrical outlet and peripherals.
2. Open the system.
3. Disconnect any cables connected to the expansion card or expansion-card riser.
4. Lift and rotate the expansion-card latch.
5. Hold the expansion card by its edges and slide the card out to remove it from the connector on the expansion-card riser.
6. If you are removing the card permanently, install a metal filler bracket over the empty expansion slot opening and close the expansion-card latch.

**🔧 NOTE:** You must install a filler bracket over an empty expansion slot to maintain Federal Communications Commission (FCC) certification of the system. The brackets also keep dust and dirt out of the system and aid in proper cooling and airflow inside the system.

7. Close the system.
8. Reconnect the system to the electrical outlet and turn the system on, including any attached peripherals.

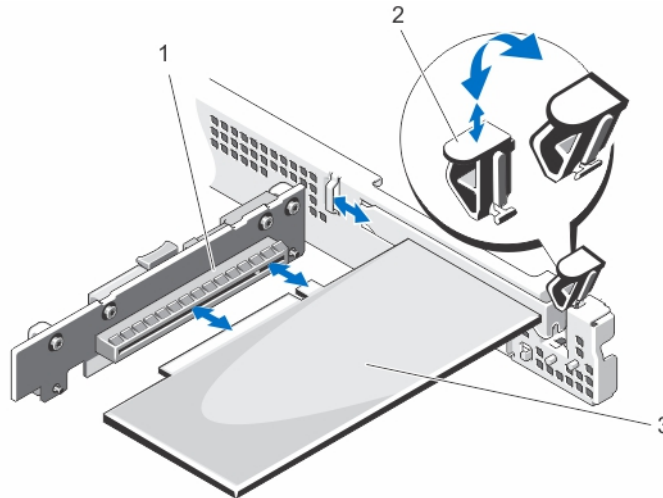

**Figure 21. Removing and Installing the Expansion Card on the Riser**

- |                             |                         |
|-----------------------------|-------------------------|
| 1. expansion-card connector | 2. expansion-card latch |
| 3. expansion card           |                         |

## Installing An Expansion Card

 **CAUTION:** Many repairs may only be done by a certified service technician. You should only perform troubleshooting and simple repairs as authorized in your product documentation, or as directed by the online or telephone service and support team. Damage due to servicing that is not authorized by Dell is not covered by your warranty. Read and follow the safety instructions that came with the product.

1. Unpack the expansion card and prepare it for installation.  
For instructions, see the documentation accompanying the card.
2. Turn off the system, including any attached peripherals, and disconnect the system from the electrical outlet and peripherals.
3. Open the system.
4. Locate the expansion-card connector on the riser.
5. Lift and rotate the expansion-card latch and remove the filler bracket.
6. Holding the card by its edges, position the card so that the card-edge connector aligns with the expansion-card connector.
7. Align the expansion-card bracket with the hook on the chassis.
8. Insert the card-edge connector into the expansion-card connector until the card is fully seated.

 **NOTE:** Ensure that the expansion card is properly seated along the chassis, so that the expansion-card latch can be closed.

9. Close the expansion-card latch.
10. Connect the cables to the expansion card.
11. Close the system.
12. Reconnect the system to the electrical outlet and turn the system on, including any attached peripherals.
13. Install any device drivers required for the card as described in the documentation for the card.

## Removing The Expansion-Card Riser

 **CAUTION:** Many repairs may only be done by a certified service technician. You should only perform troubleshooting and simple repairs as authorized in your product documentation, or as directed by the online or telephone service and support team. Damage due to servicing that is not authorized by Dell is not covered by your warranty. Read and follow the safety instructions that came with the product.

1. Turn off the system, including any attached peripherals, and disconnect the system from the electrical outlet and peripherals.
2. Open the system.
3. If installed, remove the expansion card from the riser.  
For more information, see [Removing An Expansion Card](#).
4. Press the release tab and lift the expansion-card riser from the connector on the system board.
5. Close the system.

6. Reconnect the system to the electrical outlet and turn the system on, including any attached peripherals.

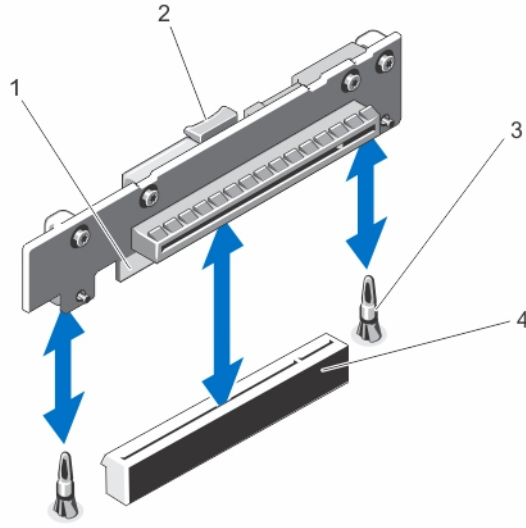

**Figure 22. Removing and Installing the Expansion-Card Riser**

- |                         |                                   |
|-------------------------|-----------------------------------|
| 1. expansion-card riser | 2. release tab                    |
| 3. guide pins (2)       | 4. expansion-card riser connector |

## Installing The Expansion-Card Riser

**⚠ CAUTION:** Many repairs may only be done by a certified service technician. You should only perform troubleshooting and simple repairs as authorized in your product documentation, or as directed by the online or telephone service and support team. Damage due to servicing that is not authorized by Dell is not covered by your warranty. Read and follow the safety instructions that came with the product.

1. Align the expansion-card riser with the connector and the guide pins on the system board.
2. Lower the expansion-card riser into place until the expansion-card riser is fully seated in the connector.
3. If applicable, reinstall the expansion card into the expansion-card riser.  
For more information, see [Installing An Expansion Card](#).
4. Close the system.
5. Reconnect the system to the electrical outlet and turn the system on, including any attached peripherals.
6. Install any device drivers required for the card as described in the documentation for the card.

# iDRAC7 Enterprise Card (Optional)

## Removing The iDRAC7 Enterprise Card

 **CAUTION:** Many repairs may only be done by a certified service technician. You should only perform troubleshooting and simple repairs as authorized in your product documentation, or as directed by the online or telephone service and support team. Damage due to servicing that is not authorized by Dell is not covered by your warranty. Read and follow the safety instructions that came with the product.

1. Turn off the system, including any attached peripherals, and disconnect the system from the electrical outlet and peripherals.
2. Disconnect the Ethernet cable from the iDRAC7 Enterprise card connector on the system back panel.
3. Open the system.
4. If installed, remove the expansion card from the expansion-card slot.
5. Disconnect any cables connected to the iDRAC7 Enterprise card.
6. Pull back slightly on the two tabs at the front edge of the card and gently lift the front edge of the card off the standoffs.

As the card releases from the standoffs, the connector under the card disengages from the system board connector.

7. Slide the card away from the back of the system until the RJ-45 connector is clear of the back panel, then lift the card out of the chassis.
8. If applicable, reinstall the expansion card.
9. If you are removing the card permanently, install a metal filler bracket over the empty expansion slot opening and close the expansion-card latch.

 **NOTE:** You must install a filler bracket over an empty expansion slot to maintain Federal Communications Commission (FCC) certification of the system. The brackets also keep dust and dirt out of the system and aid in proper cooling and airflow inside the system.

10. Replace the plastic filler plug over the port on the system back-panel.
11. Close the system.

12. Reconnect the system to the electrical outlet and turn the system on, including any attached peripherals.

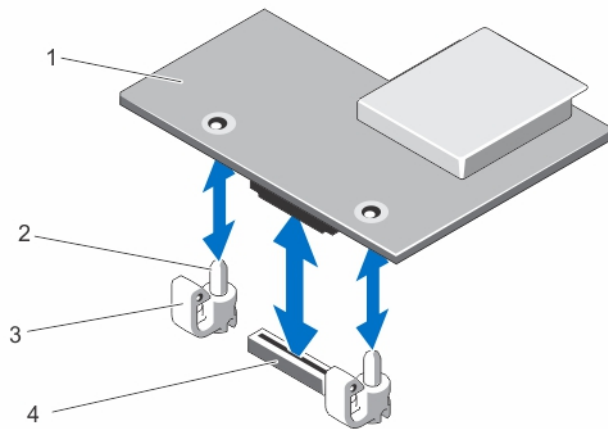

**Figure 23. Removing and Installing the iDRAC7 Enterprise Card**

- |                           |                                     |
|---------------------------|-------------------------------------|
| 1. iDRAC7 Enterprise card | 2. standoffs (2)                    |
| 3. tabs (2)               | 4. iDRAC7 Enterprise card connector |

## Installing The iDRAC7 Enterprise Card

**⚠ CAUTION:** Many repairs may only be done by a certified service technician. You should only perform troubleshooting and simple repairs as authorized in your product documentation, or as directed by the online or telephone service and support team. Damage due to servicing that is not authorized by Dell is not covered by your warranty. Read and follow the safety instructions that came with the product.

1. Unpack the iDRAC7 Enterprise card and prepare it for installation.  
For instructions, see the documentation accompanying the card.
2. Turn off the system, including any attached peripherals, and disconnect the system from the electrical outlet and peripherals.
3. Open the system.
4. If installed, remove the expansion card from the expansion slot.
5. Remove the plastic filler plug for the iDRAC7 Enterprise port from the system back panel.
6. Orient the card so that the RJ-45 connector at the bottom of the card passes through the back-panel opening.
7. Align the slots on the card with the standoffs next to the iDRAC7 connector on the system board, and lower the card into place.  
When the front of the card is fully seated, the standoffs snap into the slots on the card.
8. If applicable, reinstall the expansion card.
9. If applicable, connect cables to the iDRAC7 Enterprise card.
10. Close the system.
11. Reconnect the system to the electrical outlet and turn the system on, including any attached peripherals.
12. Install any device drivers required for the card as described in the documentation for the card.



# System Battery

## Replacing The System Battery

**⚠ WARNING:** There is a danger of a new battery exploding if it is incorrectly installed. Replace the battery only with the same or equivalent type recommended by the manufacturer. See your safety information for additional information.

**⚠ CAUTION:** Many repairs may only be done by a certified service technician. You should only perform troubleshooting and simple repairs as authorized in your product documentation, or as directed by the online or telephone service and support team. Damage due to servicing that is not authorized by Dell is not covered by your warranty. Read and follow the safety instructions that came with the product.

1. Turn off the system, including any attached peripherals, and disconnect the system from the electrical outlet and peripherals.
2. Open the system.
3. Locate the battery socket.

**⚠ CAUTION:** To avoid damage to the battery connector, you must firmly support the connector while installing or removing a battery.

4. Pull the release pin back and lift the system battery out of the battery connector.
5. To install a new system battery, pull the release pin back and slide the system battery into the battery connector.
6. Close the system.
7. Reconnect the system to the electrical outlet and turn the system on, including any attached peripherals
8. Enter the System Setup to confirm that the battery is operating properly.
9. Enter the correct time and date in the System Setup **Time** and **Date** fields.
10. Exit the System Setup.

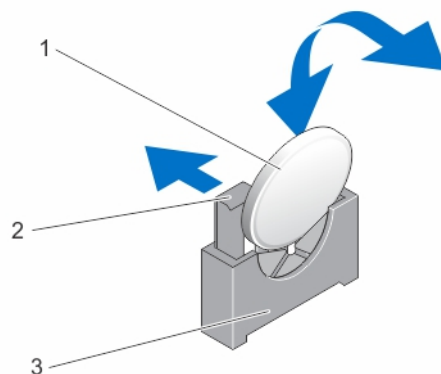

**Figure 24. Replacing the System Battery**

- |                      |                |
|----------------------|----------------|
| 1. system battery    | 2. release pin |
| 3. battery connector |                |

# Processor

## Removing The Processor

 **CAUTION:** Many repairs may only be done by a certified service technician. You should only perform troubleshooting and simple repairs as authorized in your product documentation, or as directed by the online or telephone service and support team. Damage due to servicing that is not authorized by Dell is not covered by your warranty. Read and follow the safety instructions that came with the product.

1. Before upgrading your system, download the latest system BIOS version from [dell.com/support](https://dell.com/support) and follow the instructions included in the compressed download file to install the update on your system.

 **NOTE:** You can update the system BIOS using the Lifecycle Controller.

2. Turn off the system, including any attached peripherals, and disconnect the system from the electrical outlet. When disconnected from AC power, press and hold the power button for three seconds to fully drain the system of stored power prior to removing the cover.
3. Open the system.
4. Remove the cooling shroud.

 **WARNING:** The heat sink and processor are hot to the touch for some time after the system has been powered down. Allow the heat sink and processor to cool before handling them.

 **CAUTION:** Never remove the heat sink from a processor unless you intend to remove the processor. The heat sink is necessary to maintain proper thermal conditions.

5. Using the #2 Philips screwdriver, loosen one heat-sink retention screw that secures the heat sink to the system board.
6. Wait 30 seconds for the heat sink to loosen from the processor and remove the screw diagonally opposite the first screw.
7. Repeat steps 5 and 6 for the other pair of screws.

8. Lift the heat sink away from the processor and set the heat sink aside.

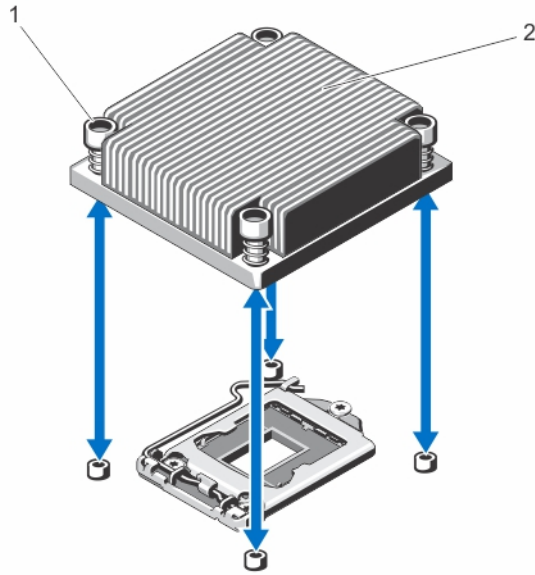

Figure 25. Removing and Installing the Processor Heat Sink

1. retention screws (4)

2. heat sink

**△ CAUTION: The processor is held in its socket under strong pressure. Be aware that the release lever can spring up suddenly if not firmly grasped.**

9. Position your thumb firmly over the processor socket-release lever and release the lever from the locked position by pushing down and out from under the tab. Rotate the lever upward.
10. Rotate the processor shield upward and out of the way.

**△ CAUTION: The socket pins are fragile and can be permanently damaged. Be careful not to bend the pins in the socket when removing the processor out of the socket.**

11. Lift the processor out of the socket and leave the release lever up so that the socket is ready for the new processor.

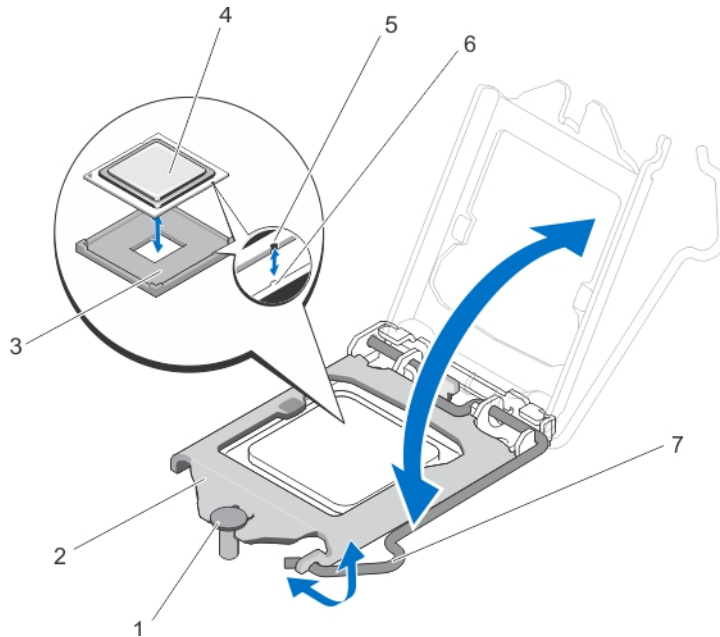

**Figure 26. Removing and Installing a Processor**

- |                                     |                    |
|-------------------------------------|--------------------|
| 1. processor shield retention screw | 2. processor       |
| 3. ZIF socket                       | 4. processor       |
| 5. notch                            | 6. socket keys (2) |
| 7. socket release lever             |                    |

**NOTE:** After removing the processor, place it in an antistatic container for reuse, return, or temporary storage. Do not touch the bottom of the processor. Touch only the side edges of the processor.







## Installing The Processor

**CAUTION:** Many repairs may only be done by a certified service technician. You should only perform troubleshooting and simple repairs as authorized in your product documentation, or as directed by the online or telephone service and support team. Damage due to servicing that is not authorized by Dell is not covered by your warranty. Read and follow the safety instructions that came with the product.

1. Before upgrading your system, download the latest system BIOS version from [dell.com/support](http://dell.com/support) and follow the instructions included in the compressed download file to install the update on your system.

**NOTE:** You can update the system BIOS using the Lifecycle Controller.

2. Turn off the system, including any attached peripherals, and disconnect the system from the electrical outlet. When disconnected from the power source, press and hold the power button for three seconds to fully drain the system of stored power prior to removing the cover.
3. Open the system.

4. Remove the cooling shroud.
  -  **WARNING: The heat sink and processor are hot to the touch for some time after the system has been powered down. Allow the heat sink and processor to cool before handling them.**
  -  **CAUTION: Never remove the heat sink from a processor unless you intend to remove the processor. The heat sink is necessary to maintain proper thermal conditions.**
5. Remove the heat sink and processor.
6. Unpack the new processor.
7. Align the processor with the socket keys on the ZIF socket.
  -  **CAUTION: Positioning the processor incorrectly can permanently damage the system board or the processor. Be careful not to bend the pins in the socket.**
  -  **CAUTION: Do not use force to seat the processor. When the processor is positioned correctly, it engages easily into the socket.**
8. With the release lever on the processor socket in the open position, align the notches on the processor with the socket keys and set the processor lightly in the socket.
9. Close the processor shield by sliding it under the retention screw until it locks into place.
10. Press the release lever down and then move it inward to secure it with the retention hook.
11. Using a clean lint-free cloth, remove the thermal grease from the heat sink.
  -  **CAUTION: Applying too much thermal grease can result in excess grease coming in contact with and contaminating the processor socket.**
12. Open the grease applicator included with your processor kit and apply all of the thermal grease in the applicator to the center of the topside of the new processor.
13. Place the heat sink on the processor.
14. Using a #2 Phillips screwdriver, tighten the heat-sink retention screws.
  -  **NOTE:** Tighten the screws diagonally opposite to each other. Do not over-tighten the heat sink retention screws when installing the heat sink. To prevent over-tightening, tighten the heat sink retention screw until resistance is felt, and stop once the screw is seated.
15. Install the cooling shroud.
16. Close the system.
17. Reconnect your system and peripherals to their electrical outlets, and turn on the system.
18. Press <F2> to enter the System Setup and check that the processor information matches the new system configuration.
19. Run the system diagnostics to verify that the new processor operates correctly.

## Power Supply Unit

Your system supports a 250 W AC power supply.

## Removing The Power Supply Unit

**CAUTION:** Many repairs may only be done by a certified service technician. You should only perform troubleshooting and simple repairs as authorized in your product documentation, or as directed by the online or telephone service and support team. Damage due to servicing that is not authorized by Dell is not covered by your warranty. Read and follow the safety instructions that came with the product.

1. Turn off the system, including any attached peripherals.
2. Disconnect the power cable from the power source.
3. Disconnect the power cable from the power supply and remove the straps that bundle and secure the system cables.
4. Open the system.
5. Disconnect all the power cables from the power supply to the system board, hard drives, and optical drive.
6. If applicable, remove the 2.5 inch/3.5 inch hard-drive cage to remove the cables secured by the wire routing latch.
7. Remove the screw securing the power supply to the chassis, slide and lift the power supply out of the chassis.

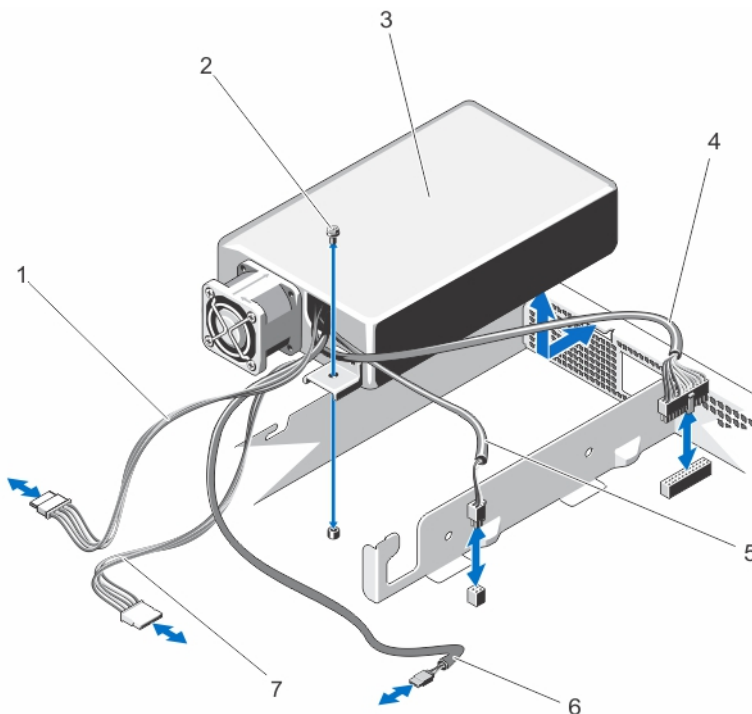

**Figure 27. Removing and Installing the Power Supply Unit**

- |                      |                       |
|----------------------|-----------------------|
| 1. P3 power cable    | 2. screw              |
| 3. power supply unit | 4. 24-pin power cable |
| 5. P2 power cable    | 6. P5 power cable     |

## Installing The Power Supply

1. Open the system.
2. Orient the power supply so that the connector fits through the back-panel opening.
3. Align the screw hole on the power supply with the hole on the chassis.
4. Tighten the screw to secure the power supply to the chassis.
5. Connect all the power cables to the system board, hard drives, and optical drive.
6. Close the system.
7. Connect the power cable to the power supply and plug the cable into a power outlet.

## System Board

### Removing The System Board

 **CAUTION:** Many repairs may only be done by a certified service technician. You should only perform troubleshooting and simple repairs as authorized in your product documentation, or as directed by the online or telephone service and support team. Damage due to servicing that is not authorized by Dell is not covered by your warranty. Read and follow the safety instructions that came with the product.

 **CAUTION:** If you are using the Trusted Program Module (TPM) with an encryption key, you may be prompted to create a recovery key during program or System Setup. Be sure to create and safely store this recovery key. If you replace this system board, you must supply the recovery key when you restart your system or program before you can access the encrypted data on your hard drives.

1. Turn off the system, including any attached peripherals, and disconnect the system from the electrical outlet.
2. If installed, remove the front bezel.
3. Open the system.
4. Remove the following:
  - a) cooling shroud

 **WARNING:** The memory modules are hot to the touch for some time after the system has been powered down. Allow time for the memory modules to cool before handling them. Handle the memory modules by the card edges and avoid touching the components.

- b) memory modules
- c) cooling fan cables
- d) expansion cards and expansion-card risers

 **WARNING:** The heat sink is hot to touch for some time after the system has been powered down. Ensure that you do not touch the heat sink while removing the system board.

- e) heat sink and processor
5. Disconnect all other cables from the system board.

 **CAUTION:** Take care not to damage the system identification button while removing the system board from the chassis.

6. Remove the screws on the system board and slide the system board toward the front of the system.

**⚠ CAUTION: Do not lift the system board assembly by grasping a memory module, processor, or other components.**

7. Hold the system board by its edges and lift the system board out of the chassis.

**⚠ CAUTION: Do not lift the system board assembly by grasping a memory module, processor, or other components.**

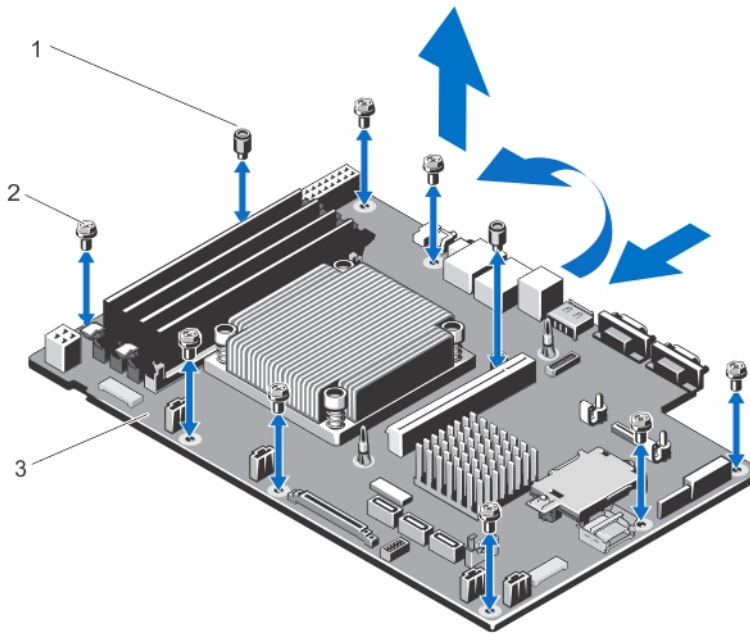

**Figure 28. Removing and Installing the System Board**

- |                                    |               |
|------------------------------------|---------------|
| 1. cooling shroud guide screws (2) | 2. screws (8) |
| 3. system board                    |               |

## Installing The System Board

**⚠ CAUTION: Many repairs may only be done by a certified service technician. You should only perform troubleshooting and simple repairs as authorized in your product documentation, or as directed by the online or telephone service and support team. Damage due to servicing that is not authorized by Dell is not covered by your warranty. Read and follow the safety instructions that came with the product.**



1. Unpack the new system board assembly.

**⚠ CAUTION: Do not lift the system board assembly by grasping a memory module, processor, or other components.**

**⚠ CAUTION: Take care not to damage the system identification button while placing the system board into the chassis.**

2. Hold the system board by its edges and angle it toward the back of the chassis.
3. Lower the system board into the chassis till the connectors at the back of the system board align with the slots on the rear wall of the chassis, and the screw holes on the system board align with the holes on the chassis.



4. Install the screws that secure the system board to the chassis.  
 **NOTE:** The cooling shroud retention screws cannot be interchangeably used with the other screws.
5. Replace the following:
  - a) heat sink and processor
  - b) expansion-card riser
  - c) expansion card
  - d) cooling fan cables
  - e) memory modules
  - f) cooling shroud
6. Reconnect all cables to the system board.  
 **NOTE:** Ensure that the cables inside the system are routed through the cable routing latch.
7. Close the system.
8. If applicable, install the front bezel.
9. Reconnect the system to the electrical outlet and turn the system on, including any attached peripherals.
10. Import your new or existing iDRAC Enterprise license. For more information, see the iDRAC7 User's Guide at [dell.com/esmmanuals](http://dell.com/esmmanuals).



# Troubleshooting Your System

## Safety First—For You And Your System

 **CAUTION:** Many repairs may only be done by a certified service technician. You should only perform troubleshooting and simple repairs as authorized in your product documentation, or as directed by the online or telephone service and support team. Damage due to servicing that is not authorized by Dell is not covered by your warranty. Read and follow the safety instructions that came with the product.

## Troubleshooting System Startup Failure

If you boot the system to the BIOS boot mode after installing an operating system from the UEFI Boot Manager, the system hangs. The reverse is also true. You must boot to the same boot mode in which you installed the operating system.

For all other startup issues, note the system messages that appear on the screen.

## Troubleshooting External Connections

Ensure that all external cables are securely attached to the external connectors on your system before troubleshooting any external devices.

## Troubleshooting The Video Subsystem

1. Check the system and power connections to the monitor.
2. Check the video interface cabling from the system to the monitor.
3. Run the appropriate diagnostic test.

If the tests run successfully, the problem is not related to video hardware.

If the tests fail, see [Getting Help](#).

## Troubleshooting A USB Device

Use the following steps to troubleshoot a USB keyboard/mouse. For other USB devices, go to step 7.

1. Disconnect the keyboard and mouse cables from the system briefly and reconnect them.
2. Connect the keyboard/mouse to the USB port(s) on the opposite side of the system.
3. If the problem is resolved, restart the system, enter the System Setup, and check if the non-functioning USB ports are enabled.
4. Replace the keyboard/mouse with another working keyboard/mouse.
5. If the problem is resolved, replace the faulty keyboard/mouse.

6. If the problem is not resolved, proceed to the next step to begin troubleshooting the other USB devices attached to the system.
7. Power down all attached USB devices and disconnect them from the system.
8. Reboot the system and, if your keyboard is functioning, enter the System Setup. Verify that all USB ports are enabled on the **Integrated Devices** screen, in the System Setup options.  
If your keyboard is not functioning, you can also use remote access. If the system is not accessible, reset the NVRAM\_CLR jumper inside your system and restore the BIOS to the default settings.
9. Reconnect and power on each USB device one at a time.
10. If a device causes the same problem, power down the device, replace the USB cable with a known good cable, and power up the device.

If all troubleshooting fails, see [Getting Help](#).

## Troubleshooting A Serial I/O Device

1. Turn off the system and any peripheral devices connected to the serial port.
2. Swap the serial interface cable with a working cable, and turn on the system and the serial device.  
If the problem is resolved, replace the interface cable with a known good cable.
3. Turn off the system and the serial device, and swap the device with a comparable device.
4. Turn on the system and the serial device.

If the problem persists, see [Getting Help](#).

## Troubleshooting A NIC

1. Run the appropriate diagnostic test. See Using System Diagnostics for available diagnostic tests.
2. Reboot the system and check for any system messages pertaining to the NIC controller.
3. Check the appropriate indicator on the NIC connector:
  - If the link indicator does not light, check all cable connections.
  - If the activity indicator does not light, the network driver files might be damaged or missing. Remove and reinstall the drivers if applicable. See the NIC's documentation.
  - If applicable, change the autonegotiation setting.
  - Use another connector on the switch or hub.
4. Ensure that the appropriate drivers are installed and the protocols are bound. See the NIC's documentation.
5. Enter the System Setup and confirm that the NIC ports are enabled on the **Integrated Devices** screen.
6. Ensure that the NICs, hubs, and switches on the network are all set to the same data transmission speed and duplex. See the documentation for each network device.
7. Ensure that all network cables are of the proper type and do not exceed the maximum length.

If all troubleshooting fails, see [Getting Help](#).

## Troubleshooting A Wet System

 **CAUTION:** Many repairs may only be done by a certified service technician. You should only perform troubleshooting and simple repairs as authorized in your product documentation, or as directed by the online or telephone service and support team. Damage due to servicing that is not authorized by Dell is not covered by your warranty. Read and follow the safety instructions that came with the product.

1. Turn off the system and attached peripherals, and disconnect the system from the electrical outlet.
2. Open the system.
3. Disassemble components from the system:
  - Hard drives
  - Hard-drive backplane
  - USB memory key
  - Cooling shroud
  - Expansion-card risers (if present)
  - Expansion cards
  - Power supply(s)
  - Cooling-fan assembly (if present)
  - Cooling fans
  - Processor(s) and heat sink(s)
  - Memory modules
4. Let the system dry thoroughly for at least 24 hours.
5. Reinstall the components you removed in step 3.
6. Close the system.
7. Turn on the system and attached peripherals.  
If the system does not start properly, see [Getting Help](#).
8. If the system starts properly, shut down the system and reinstall all of the expansion cards that you removed.
9. Run the appropriate diagnostic test. For more information, see Using System Diagnostics.

If the tests fail, see [Getting Help](#).

## Troubleshooting A Damaged System

 **CAUTION:** Many repairs may only be done by a certified service technician. You should only perform troubleshooting and simple repairs as authorized in your product documentation, or as directed by the online or telephone service and support team. Damage due to servicing that is not authorized by Dell is not covered by your warranty. Read and follow the safety instructions that came with the product.

1. Turn off the system and attached peripherals, and disconnect the system from the electrical outlet.
2. Open the system.

3. Ensure that the following components are properly installed:
  - Cooling shroud
  - Expansion-card risers (if present)
  - Expansion cards
  - Power supply(s)
  - Cooling-fan assembly (if present)
  - Cooling fans
  - Processor(s) and heat sink(s)
  - Memory modules
  - Hard-drive carriers
  - Hard-drive backplane
4. Ensure that all cables are properly connected.
5. Close the system.
6. Run the appropriate diagnostic test. For more information, see Using System Diagnostics.

If the tests fail, see [Getting Help](#).

## Troubleshooting The System Battery

 **CAUTION:** Many repairs may only be done by a certified service technician. You should only perform troubleshooting and simple repairs as authorized in your product documentation, or as directed by the online or telephone service and support team. Damage due to servicing that is not authorized by Dell is not covered by your warranty. Read and follow the safety instructions that came with the product.

 **NOTE:** If the system is turned off for long periods of time (for weeks or months), the NVRAM may lose its system configuration information. This situation is caused by a defective battery.

1. Re-enter the time and date in the System Setup.
2. Turn off the system and disconnect it from the electrical outlet for at least one hour.
3. Reconnect the system to the electrical outlet and turn on the system.
4. Enter the System Setup.

If the date and time are not correct in the System Setup, check the SEL for system battery messages.

If the problem persists, see [Getting Help](#).

 **NOTE:** Some software may cause the system time to speed up or slow down. If the system seems to operate normally except for the time kept in the System Setup, the problem may be caused by software rather than by a defective battery.

## Troubleshooting The Power Supply

 **CAUTION:** Many repairs may only be done by a certified service technician. You should only perform troubleshooting and simple repairs as authorized in your product documentation, or as directed by the online or telephone service and support team. Damage due to servicing that is not authorized by Dell is not covered by your warranty. Read and follow the safety instructions that came with the product.

1. Reseat the power supply by removing and reinstalling it.

 **NOTE:** After installing a power supply, allow several seconds for the system to recognize the power supply and to determine if it is working properly.

2. If the problem persists, see [Getting Help](#).

## Troubleshooting Cooling Problems

 **CAUTION:** Many repairs may only be done by a certified service technician. You should only perform troubleshooting and simple repairs as authorized in your product documentation, or as directed by the online or telephone service and support team. Damage due to servicing that is not authorized by Dell is not covered by your warranty. Read and follow the safety instructions that came with the product.

Ensure that none of the following conditions exist:

- System cover, cooling shroud, EMI filler panel, memory-module blank, or back-filler bracket is removed.
- Ambient temperature is too high.
- External airflow is obstructed.
- A cooling fan is removed or has failed.
- The expansion card installation guidelines have not been followed.

## Troubleshooting Cooling Fans

 **CAUTION:** Many repairs may only be done by a certified service technician. You should only perform troubleshooting and simple repairs as authorized in your product documentation, or as directed by the online or telephone service and support team. Damage due to servicing that is not authorized by Dell is not covered by your warranty. Read and follow the safety instructions that came with the product.

1. Open the system.
2. Reseat the fan or the fan's power cable.
3. If the fan functions properly, close the system.

If the problem persists, see [Getting Help](#).

# Troubleshooting System Memory

 **CAUTION:** Many repairs may only be done by a certified service technician. You should only perform troubleshooting and simple repairs as authorized in your product documentation, or as directed by the online or telephone service and support team. Damage due to servicing that is not authorized by Dell is not covered by your warranty. Read and follow the safety instructions that came with the product.

1. If the system is operational, run the appropriate diagnostic test. See Using System Diagnostics for available diagnostic tests.  
If diagnostics indicates a fault, follow the corrective actions provided by the diagnostic program.
2. If the system is not operational, turn off the system and attached peripherals, and unplug the system from the power source. Wait at least 10 seconds and then reconnect the system to power.
3. Turn on the system and attached peripherals and note the messages on the screen.  
If an error message is displayed indicating a fault with a specific memory module, go to step 12.
4. Enter the System Setup and check the system memory setting. Make any changes to the memory settings, if needed.  
If the memory settings match the installed memory but a problem is still indicated, go to step 12.
5. Turn off the system and attached peripherals, and disconnect the system from the electrical outlet.
6. Open the system.
7. Check the memory channels and ensure that they are populated correctly.
8. Reseat the memory modules in their sockets.
9. Close the system.
10. Enter the System Setup and check the system memory setting.  
If the problem is not resolved, proceed with the next step.
11. Open the system.
12. If a diagnostic test or error message indicates a specific memory module as faulty, swap or replace the module with a known good memory module.
13. To troubleshoot an unspecified faulty memory module, replace the memory module in the first DIMM socket with a module of the same type and capacity.  
If an error message is displayed on the screen, this may indicate a problem with the installed DIMM type(s), incorrect DIMM installation, or defective DIMM(s). Follow the on-screen instructions to resolve the problem. For more information, see General Memory Module Installation Guidelines.
14. Close the system.
15. As the system boots, observe any error message that is displayed and the diagnostic indicators on the front of the system.
16. If the memory problem is still indicated, repeat step 12 through step 15 for each memory module installed.

If the problem persists after all memory modules have been checked, see [Getting Help](#).



## Troubleshooting An Internal USB Key

 **CAUTION:** Many repairs may only be done by a certified service technician. You should only perform troubleshooting and simple repairs as authorized in your product documentation, or as directed by the online or telephone service and support team. Damage due to servicing that is not authorized by Dell is not covered by your warranty. Read and follow the safety instructions that came with the product.

1. Enter the System Setup and ensure that the **USB key port** is enabled on the **Integrated Devices** screen.
2. Turn off the system and attached peripherals, and disconnect the system from the electrical outlet.
3. Open the system.
4. Locate the USB key and reseal it.
5. Close the system.
6. Turn on the system and attached peripherals and check if the USB key is functioning.
7. If the problem is not resolved, repeat step 2 and step 3.
8. Insert a different USB key that you know works properly.
9. Close the system.

If the problem is not resolved, see [Getting Help](#).

## Troubleshooting An SD Card

 **CAUTION:** Many repairs may only be done by a certified service technician. You should only perform troubleshooting and simple repairs as authorized in your product documentation, or as directed by the online or telephone service and support team. Damage due to servicing that is not authorized by Dell is not covered by your warranty. Read and follow the safety instructions that came with the product.

 **NOTE:** Certain SD cards have a physical write-protect switch on the card. If the write-protect switch is turned on then the SD card is not writeable.

1. Enter the System Setup and ensure that the **Internal SD Card Port** is enabled.
2. Turn off the system, including any attached peripherals, and disconnect the system from the electrical outlet.
3. Open the system.

 **CAUTION:** If the **Internal SD Card Redundancy** option is set to **Mirror Mode** in the **Integrated Devices** screen of the **System Setup**, you must follow the instructions in step 4 through step 7 to avoid loss of data.

 **NOTE:** When an SD card failure occurs, the internal dual SD module controller notifies the system. On the next reboot, the system displays a message indicating the failure.

4. If the **Internal SD Card Redundancy** option is set to **Disabled**, replace the failed SD card with a new SD card.
5. If SD card 1 has failed, remove the card from SD card slot 1. If SD card 2 has failed, install a new SD card in SD card slot 2 and proceed to step 7.
6. Remove the card present in SD card slot 2 and insert it into SD card slot 1.
7. Insert the new SD card into SD card slot 2.

8. Close the system.
9. Reconnect the system to its electrical outlet and turn the system on, including any attached peripherals.
10. Enter the System Setup and ensure that the **Internal SD Card Port** and **Internal SD Card Redundancy** mode is enabled.
11. Check if the SD card is functioning properly.  
If the problem persists, see [Getting Help](#).

## Troubleshooting An Optical Drive

 **CAUTION:** Many repairs may only be done by a certified service technician. You should only perform troubleshooting and simple repairs as authorized in your product documentation, or as directed by the online or telephone service and support team. Damage due to servicing that is not authorized by Dell is not covered by your warranty. Read and follow the safety instructions that came with the product.

1. Try using a different CD or DVD.
2. Enter the System Setup and ensure that the integrated SATA controller and the drive's SATA port are enabled.
3. Run the appropriate diagnostic test.
4. Turn off the system and attached peripherals, and disconnect the system from the electrical outlet.
5. Open the system.
6. Remove the front bezel.
7. Ensure that the interface cable is securely connected to the optical drive and to the controller.
8. Ensure that a power cable is properly connected to the drive.
9. Close the system.

If the problem is not resolved, see [Getting Help](#).

## Troubleshooting A Hard Drive

 **CAUTION:** Many repairs may only be done by a certified service technician. You should only perform troubleshooting and simple repairs as authorized in your product documentation, or as directed by the online or telephone service and support team. Damage due to servicing that is not authorized by Dell is not covered by your warranty. Read and follow the safety instructions that came with the product.

 **CAUTION:** This troubleshooting procedure can erase data stored on the hard drive. Before you proceed, back up all files on the hard drive.

1. Run the appropriate diagnostic test. For more information, see Using System Diagnostics.  
Depending on the results of the diagnostics test, proceed as needed through the following steps.
2. If your system has a RAID controller and your hard drives are configured in a RAID array, perform the following steps:
  - a) Reboot the system and press <F10> during system startup to run the Lifecycle Controller, and then run the Hardware Configuration wizard to check the RAID configuration.  
See the Lifecycle Controller documentation or online help for information on RAID configuration.
  - b) Ensure that the hard drive(s) are configured correctly for the RAID array.
  - c) Take the hard drive offline and reseal the drive.
  - d) Exit the configuration utility and allow the system to boot to the operating system.
3. Ensure that the required device drivers for your controller card are installed and are configured correctly. See the operating system documentation for more information.
4. Reboot the system and enter the System Setup.
5. Verify that the controller is enabled and the drives are displayed in the System Setup.

If the problem persists, try troubleshooting the expansion cards or see [Getting Help](#).

## Troubleshooting Expansion Cards

 **CAUTION:** Many repairs may only be done by a certified service technician. You should only perform troubleshooting and simple repairs as authorized in your product documentation, or as directed by the online or telephone service and support team. Damage due to servicing that is not authorized by Dell is not covered by your warranty. Read and follow the safety instructions that came with the product.

 **NOTE:** When troubleshooting an expansion card, see the documentation for your operating system and the expansion card.

1. Run the appropriate diagnostic test. For more information, see Using System Diagnostics.
2. Turn off the system and attached peripherals, and disconnect the system from the electrical outlet.
3. Open the system.
4. Ensure that each expansion card is firmly seated in its connector.
5. Close the system.
6. If the problem is not resolved, turn off the system and attached peripherals, and disconnect the system from the electrical outlet.
7. Open the system.
8. Remove all expansion cards installed in the system.
9. Close the system.
10. Run the appropriate diagnostic test. For more information, see Using System Diagnostics.

If the tests fail, see [Getting Help](#).

11. For each expansion card you removed in step 8, perform the following steps:
  - a) Turn off the system and attached peripherals, and disconnect the system from the electrical outlet.
  - b) Open the system.
  - c) Reinstall one of the expansion cards.
  - d) Close the system.
  - e) Run the appropriate diagnostic test. For more information, see Using System Diagnostics.

If the problem persists, see [Getting Help](#).

## Troubleshooting The Processor



**CAUTION: Many repairs may only be done by a certified service technician. You should only perform troubleshooting and simple repairs as authorized in your product documentation, or as directed by the online or telephone service and support team. Damage due to servicing that is not authorized by Dell is not covered by your warranty. Read and follow the safety instructions that came with the product.**

1. Run the appropriate diagnostics test. See [Using System Diagnostics](#) for available diagnostic tests.
2. Turn off the system and attached peripherals, and disconnect the system from the electrical outlet.
3. Open the system.
4. Ensure that the processor and heat sink are properly installed.
5. Close the system.
6. Run the appropriate diagnostic test. For more information, see [Using System Diagnostics](#).

If a problem is still indicated, see [Getting Help](#).

# Using System Diagnostics

If you experience a problem with your system, run the system diagnostics before contacting Dell for technical assistance. The purpose of running system diagnostics is to test your system hardware without requiring additional equipment or risking data loss. If you are unable to fix the problem yourself, service and support personnel can use the diagnostics results to help you solve the problem.

## Dell Embedded System Diagnostics

 **NOTE:** Also known as Enhanced Pre-boot System Assessment (ePSA) diagnostics.

The embedded system diagnostics provides a set of options for particular device groups or devices allowing you to:

- Run tests automatically or in an interactive mode
- Repeat tests
- Display or save test results
- Run thorough tests to introduce additional test options to provide extra information about the failed device(s)
- View status messages that inform you if tests are completed successfully
- View error messages that inform you of problems encountered during testing

## When To Use The Embedded System Diagnostics

If a major component or device in the system does not operate properly, running the embedded system diagnostics may indicate component failure.

## Running The Embedded System Diagnostics

The embedded system diagnostics program is run from the Dell Lifecycle Controller.

 **CAUTION:** Use the embedded system diagnostics to test only your system. Using this program with other systems may cause invalid results or error messages.

1. As the system boots, press <F11>.
2. Use the up and down arrow keys to select **System Utilities** → **Launch Dell Diagnostics**.  
The **ePSA Pre-boot System Assessment** window is displayed, listing all devices detected in the system. The diagnostics starts executing the tests on all the detected devices.

## System Diagnostic Controls

Menu	Description
Configuration	Displays the configuration and status information of all detected devices.





<b>Menu</b>	<b>Description</b>
<b>Results</b>	Displays the results of all tests that are executed.
<b>System Health</b>	Provides the current overview of the system performance.
<b>Event Log</b>	Displays a time-stamped log of the results of all tests run on the system. This is displayed if at least one event description is recorded.

# Jumpers And Connectors

## System Board Jumper Settings

For information on resetting the password jumper to disable a password, see [Disabling A Forgotten Password](#).

**Table 3. System Board Jumper Settings**

Jumper	Setting	Description
PWRD_EN	 2 4 6 (default)	The password feature is enabled (pins 2–4).
	 2 4 6	The password feature is disabled (pins 4–6). iDRAC local access is unlocked at the next AC power cycle.
NVRAM_CLR	 1 3 5 (default)	The configuration settings are retained at system boot (pins 3–5).
	 1 3 5	The configuration settings are cleared at the next system boot (pins 1–3).

# System Board Connectors

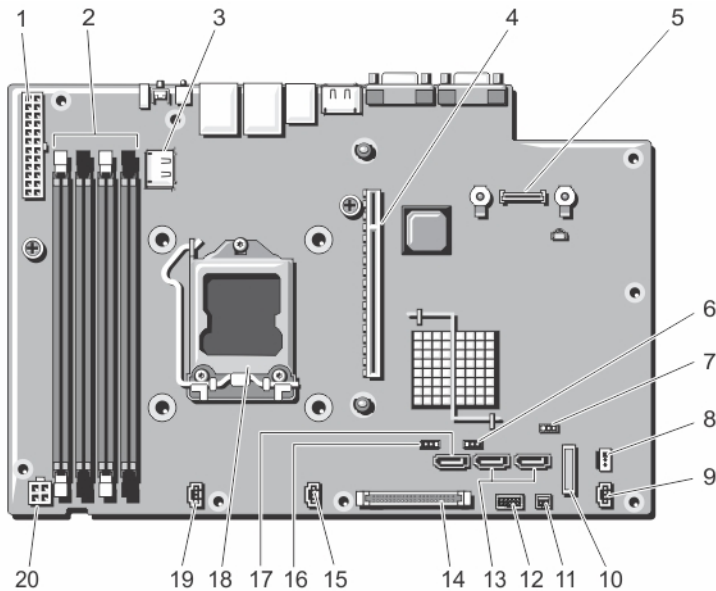

Figure 29. System Board Jumpers and Connectors

Item	Connector	Description
1	POWER CONN	Power connector
2	2, 4, 1,3	Memory module sockets
3	INT_USB1	USB connector
4	IO_Riser1	Expansion-card riser connector
5	iDRAC_ENTERPRISE	iDRAC7 enterprise card connector
6	NVRAM CLR	NVRAM clear jumper
7	CMOS CLR	CMOS clear jumper
8	INTRUSION	Intrusion switch connector
9	FAN3	Cooling fan 3 connector
10	BATTERY	Battery connector
11	PERC HDD ACTIVE	PERC card connector
12	USB_SIGNAL	Control panel USB signal connector
13	SATA_B	SATA connector B
	SATA_A	SATA connector A
14	CTRL_PNL	Control panel connector
15	FAN2	Cooling fan 2 connector



Item	Connector	Description
16	PWRD_EN	Password enable jumper
17	ODD/SATA_E	ODD/SATA connector E
18	CPU	Processor
19	FAN1	Cooling fan 1 connector
20	POWER_12V_1	P2 power connector

## Disabling A Forgotten Password

The system's software security features include a system password and a setup password. The password jumper enables these password features or disables them and clears any password(s) currently in use.

 **CAUTION:** Many repairs may only be done by a certified service technician. You should only perform troubleshooting and simple repairs as authorized in your product documentation, or as directed by the online or telephone service and support team. Damage due to servicing that is not authorized by Dell is not covered by your warranty. Read and follow the safety instructions that came with the product.

1. Turn off the system, including any attached peripherals, and disconnect the system from the electrical outlet.
2. Open the system.
3. Move the jumper on the system-board jumper from pins 4 and 6 to pins 2 and 4.
4. Close the system.

The existing passwords are not disabled (erased) until the system boots with the Jumper on pins 2 and 4. However, before you assign a new system and/or setup password, you must move the jumper back to pins 4 and 6.

 **NOTE:** If you assign a new system and/or setup password with the jumper on pins 2 and 4, the system disables the new password(s) the next time it boots.

5. Reconnect the system to the electrical outlet and turn the system on, including any attached peripherals.
6. Turn off the system, including any attached peripherals, and disconnect the system from the electrical outlet.
7. Open the system.
8. Move the jumper on the system-board jumper from pins 2 and 4 to pins 4 and 6.
9. Close the system.
10. Reconnect the system to the electrical outlet and turn the system on, including any attached peripherals.
11. Assign a new system and/or setup password.



# Technical Specifications

<b>Processor</b>	
Processor type	Intel Core i3-4130 and Core i3-4330 processorproduct family Intel Pentium processor G3430 and G3420 Intel Celeron processor G1820
<b>Expansion Bus</b>	
Bus type	PCI Express Generation 3
Expansion slots using riser card	One half-height, full-length x16 link
<b>Memory</b>	
Architecture	1600 MT/s or 1333 MT/s unbuffered Error Correcting Code (ECC) DIMMs
Memory module sockets	Four 240-pin
Memory module capacities	
UDIMM	4GB (single-rank) and 8 GB (dual-rank)
Minimum RAM	4 GB
Maximum RAM	32 GB
<b>Drives</b>	
Hard drives	Up to two 3.5 inch Enterprise Class and Entry Class SATA, SAS, or Nearline SAS hard drives, or Up to two 2.5 inch SAS, SATA, or Nearline SAS hard drives
Optical drive	One optional slim 12.7 mm SATA DV-DROM or DVD+/-RW drive
	 <b>NOTE:</b> DVD devices are data only.
<b>Connectors</b>	
<b>Back</b>	
NIC	Two 10/100/1000 Mbps
Serial	9-pin, DTE, 16550-compatible

---

**Connectors**

---

USB	Two 4-pin, USB 3.0-compliant
Video	15-pin VGA

**Front**

USB	Two 4-pin, USB 2.0-compliant
Video	15-pin VGA

**Internal**

USB	One 4-pin, USB 2.0-compliant
-----	------------------------------

---

**Environmental**

---



**NOTE:** For additional information about environmental measurements for specific system configurations, see [dell.com/environmental\\_datasheets](http://dell.com/environmental_datasheets).

**Temperature**

Maximum Temperature Gradient (Operating and Storage)	10 °C/h (50 °F/h)
Storage Temperature Limits	-40 °C to 65 °C (-40 °F to 149 °F)

**Temperature (Continuous Operation)**

Temperature Ranges (for altitude less than 950 m or 3117 ft)	10 °C to 35 °C (50 °F to 95 °F) with no direct sunlight on the equipment.
Humidity Percentage Range	10% to 80% Relative Humidity with 29 °C (84.2 °F) maximum dew point.

**Relative Humidity**

Storage	5% to 95% RH with 33 °C (91 °F) maximum dew point. Atmosphere must be non-condensing at all times.
---------	--

**Maximum Vibration**

Operating	0.26 G <sub>rms</sub> at 5 Hz to 350 Hz for 15 minutes (all operation orientations).
Storage	1.88 G <sub>rms</sub> at 10 Hz to 500 Hz for 15 minutes (all six sides tested).

**Maximum Shock**

Operating	One shock pulse (one pulse each side of the system) of 31 G for 2.6 ms in the operational orientation.
Storage	Six consecutively executed shock pulses in the positive and negative x, y, and z axes (one pulse on each side of the system) of 71 G for up to 2 ms. Six consecutively executed shock pulses in the positive and negative x, y, and z axes (one pulse on each side of the system) of 32 G faired square wave pulse with velocity change at 270 inches/second (686 centimeters/second).

---

## Environmental

---

### Maximum Altitude

Operating	3048 m (10,000)
Storage	12,000 m (39,370 ft).

### Operating Altitude De-rating

$\leq 35\text{ }^{\circ}\text{C}$ (95 °F)	Maximum temperature is reduced by 1 °C/300 m (1 °F/547 ft) above 950 m (3,117 ft).
---	--

### Particulate Contamination

 **NOTE:** This section defines the limits to help avoid IT equipment damage and/or failure from particulates and gaseous contamination. If it is determined that levels of particulates or gaseous pollution are beyond the limits specified below and are the reason for the damage and/or failures to your equipment, it may be necessary for you to re-mediate the environmental conditions that are causing the damage and/or failures. Re-mediation of environmental conditions will be the responsibility of the customer.

#### Air Filtration

 **NOTE:** Applies to data center environments only. Air filtration requirements do not apply to IT equipment designed to be used outside a data center, in environments such as an office or factory floor.

Data center air filtration as defined by ISO Class 8 per ISO 14644-1 with a 95% upper confidence limit.

 **NOTE:** Air entering the data center must have MERV11 or MERV13 filtration.

#### Conductive Dust

 **NOTE:** Applies to data center and non-data center environments.

Air must be free of conductive dust, zinc whiskers, or other conductive particles.

#### Corrosive Dust

 **NOTE:** Applies to data center and non-data center environments.

- Air must be free of corrosive dust.
- Residual dust present in the air must have a deliquescent point less than 60% relative humidity.

### Gaseous Contamination

 **NOTE:** Maximum corrosive contaminant levels measured at  $\leq 50\%$  relative humidity.

Copper Coupon Corrosion Rate <300 Å/month per Class G1 as defined by ANSI/ISA71.04-1985.

Silver Coupon Corrosion Rate <200 Å/month as defined by AHSRAE TC9.9.



# System Messages

## System Error Messages

System error messages appear on the monitor to notify you of a possible problem with the system. These messages refer to events recorded in the System Event Log (SEL). For information on the SEL and configuring system management settings, see the systems management software documentation.

 **NOTE:** If you receive a system error message not listed here, check the documentation of the application that was running when the message was displayed or the operating system's documentation for an explanation of the message and recommended action.

 **NOTE:** In some messages, a particular system component is identified by name ("`<name>`") component number ("`<number>`"), or location ("`bay`").

Error Code	Message Information	
ASR0000	<b>Message</b>	The watchdog timer expired.
	<b>Details</b>	The operating system or an application failed to communicate within the time-out period.
	<b>Action</b>	Check the operating system, application, hardware, and system event log for exception events.
ASR0001	<b>Message</b>	The watchdog timer reset the system.
	<b>Details</b>	The operating system or an application failed to communicate within the time-out period. The system was reset.
	<b>Action</b>	Check the operating system, application, hardware, and system event log for exception events.
ASR0002	<b>Message</b>	The watchdog timer powered off the system.
	<b>Details</b>	The operating system or an application failed to communicate within the time-out period. The system was shut down.
	<b>Action</b>	Check the operating system, application, hardware, and system event log for exception events.
ASR0003	<b>Message</b>	The watchdog timer power cycled the system.

Error Code	Message Information	
	<b>Details</b>	The operating system or an application failed to communicate within the time-out period. The system was power-cycled.
	<b>Action</b>	Check the operating system, application, hardware, and system event log for exception events.
BAT0002	<b>Message</b>	The system board battery has failed.
	<b>Details</b>	The system board battery is either missing or bad.
	<b>Action</b>	See <a href="#">Getting Help</a> .
BAT0017	<b>Message</b>	The <name> battery has failed.
	<b>Details</b>	The <name> battery is either missing, bad, or unable to charge due to thermal issues.
	<b>Action</b>	Check system fans. If the problem persists, see <a href="#">Getting Help</a> .
CPU0000	<b>Message</b>	CPU <number> has an internal error (IERR).
	<b>Details</b>	System Event Log and Operating System Logs may indicate that the exception is external to the processor.
	<b>Action</b>	Review System Event Log and Operating System Logs. If the issue persists, see <a href="#">Getting Help</a> .
CPU0001	<b>Message</b>	CPU <number> has a thermal trip (over-temperature) event.
	<b>Details</b>	The processor temperature increased beyond the operational range.
	<b>Action</b>	Review the logs for fan failures. If no fan failures are detected, check inlet temperature (if available) and reinstall processor heat sink. If the problem persists, see <a href="#">Getting Help</a> .
CPU0005	<b>Message</b>	CPU <number> configuration is unsupported.
	<b>Details</b>	System is unable to boot or may run in a degraded state.
	<b>Action</b>	Review the technical specifications for supported processor types.
CPU0010	<b>Message</b>	CPU <number> is throttled.
	<b>Details</b>	The CPU is throttled due to thermal or power conditions.
	<b>Action</b>	Review system logs for power or thermal exceptions.



Error Code	Message Information	
CPU0023	<b>Message</b>	CPU <number> is absent.
	<b>Action</b>	Verify processor installation. If present, re-seat the processor.
CPU0204	<b>Message</b>	CPU <number> <name> voltage is outside of range.
	<b>Details</b>	Voltages outside the allowable range may damage electrical components or may cause the system to shutdown.
	<b>Action</b>	<ol style="list-style-type: none"> <li>1. Turn off the system and remove input power for one minute.</li> <li>2. Ensure the processor is seated correctly.</li> <li>3. Reapply input power and turn on the system.</li> <li>4. If the issue persists, see <a href="#">Getting Help</a>.</li> </ol>
CPU0700	<b>Message</b>	CPU <number> initialization error detected.
	<b>Details</b>	System BIOS was unable to initialize the processor.
	<b>Action</b>	<ol style="list-style-type: none"> <li>1. Turn off the system and remove input power for one minute.</li> <li>2. Ensure the processor is seated correctly.</li> <li>3. Reapply input power and turn on the system.</li> <li>4. If the issue persists, see <a href="#">Getting Help</a>.</li> </ol>
CPU0701	<b>Message</b>	CPU <number> protocol error detected.
	<b>Details</b>	System event log and operating system logs may indicate that the exception is external to the processor.
	<b>Action</b>	<ol style="list-style-type: none"> <li>1. Check system and operating system logs for exceptions. If no exceptions are found, continue.</li> <li>2. Turn off the system and remove input power for one minute.</li> <li>3. Ensure the processor is seated correctly.</li> <li>4. Reapply input power and turn on the system.</li> <li>5. If the issue persists, see <a href="#">Getting Help</a>.</li> </ol>
CPU0702	<b>Message</b>	CPU bus parity error detected.
	<b>Details</b>	System event log and operating system logs may indicate that the exception is external to the processor.

Error Code	Message Information	
CPU0703	<b>Action</b>	<ol style="list-style-type: none"> <li>1. Check system and operating system logs for exceptions. If no exceptions are found, continue.</li> <li>2. Turn off the system and remove input power for one minute.</li> <li>3. Ensure the processor is seated correctly.</li> <li>4. Reapply input power and turn on the system.</li> <li>5. If the issue persists, see <a href="#">Getting Help</a>.</li> </ol>
	<b>Message</b>	CPU bus initialization error detected.
	<b>Details</b>	System event log and operating system logs may indicate that the exception is external to the processor.
CPU0704	<b>Action</b>	<ol style="list-style-type: none"> <li>1. Check system and operating system logs for exceptions. If no exceptions are found, continue.</li> <li>2. Turn off the system and remove input power for one minute.</li> <li>3. Ensure the processor is seated correctly.</li> <li>4. Reapply input power and turn on the system.</li> <li>5. If the issue persists, see <a href="#">Getting Help</a>.</li> </ol>
	<b>Message</b>	CPU <number> machine check error detected.
	<b>Details</b>	System event log and operating system logs may indicate that the exception is external to the processor.
FAN0000	<b>Action</b>	<ol style="list-style-type: none"> <li>1. Check system and operating system logs for exceptions. If no exceptions are found, continue.</li> <li>2. Turn off the system and remove input power for one minute.</li> <li>3. Ensure the processor is seated correctly.</li> <li>4. Reapply input power and turn on the system.</li> <li>5. If the issue persists, see <a href="#">Getting Help</a>.</li> </ol>
	<b>Message</b>	Fan <number> RPM is less than the lower warning threshold.
	<b>Details</b>	Fan operating speed is out of range.
FAN0001	<b>Action</b>	Remove and reinstall the fan. If the issue persists, see <a href="#">Getting Help</a> .
	<b>Message</b>	Fan <number> RPM is less than the lower critical threshold.
	<b>Details</b>	Fan operating speed is out of range.

Error Code	Message Information	
	Action	Remove and reinstall the fan. If the issue persists, see <a href="#">Getting Help</a> .
HWC1001	Message	The <name> is absent.
	Details	The absent device may be necessary for proper operation. System functionality may be degraded.
	Action	Reinstall or reconnect the hardware.
HWC2003	Message	The storage <name> cable is not connected, or is improperly connected.
	Details	The cable may be necessary for proper operation. System functionality may be degraded.
	Action	Check if the cable is present, then reinstall or reconnect.
HWC2005	Message	The system board <name> cable is not connected, or is improperly connected.
	Details	The cable may be necessary for proper operation. System functionality may be degraded.
	Action	Check if the cable is present, then reinstall or reconnect.
MEM0000	Message	Persistent correctable memory errors detected on a memory device at location(s) <location>.
	Details	This is an early indicator of a possible future uncorrectable error.
	Action	Re-seat the memory modules. If the issue persists, see <a href="#">Getting Help</a> .
MEM0001	Message	Multi-bit memory errors detected on a memory device at location(s) <location>.
	Details	The memory module has encountered an uncorrectable error. System performance may be degraded. The operating system and/or applications may fail as a result.
	Action	Re-seat the memory modules. If the issue persists, see <a href="#">Getting Help</a> .
MEM0007	Message	Unsupported memory configuration; check memory device at location <location>.

Error Code	Message Information	
	Details	The memory may not be seated correctly, misconfigured, or has failed. Memory size is reduced.
	Action	Check the memory configuration. Re-seat the memory modules. If the issue persists, see <a href="#">Getting Help</a> .
MEM0701	Message	Correctable memory error rate exceeded for <location>.
	Details	The memory may not be operational. This an early indicator of a possible future uncorrectable error.
	Action	Re-seat the memory modules. If the issue persists, see <a href="#">Getting Help</a> .
MEM0702	Message	Correctable memory error rate exceeded for <location>.
	Details	The memory may not be operational. This an early indicator of a possible future uncorrectable error.
	Action	Re-seat the memory modules. If the issue persists, see <a href="#">Getting Help</a> .
MEM1205	Message	Memory mirror redundancy is lost. Check memory device at location(s) <location>.
	Details	The memory may not be seated correctly, misconfigured, or has failed.
	Action	Check the memory configuration. Re-seat the memory modules. If the issue persists, see <a href="#">Getting Help</a> .
MEM1208	Message	Memory spare redundancy is lost. Check memory device at location <location>.
	Details	Memory sparing is no longer available.
	Action	Re-seat the memory modules. If the issue persists, see <a href="#">Getting Help</a> .
MEM8000	Message	Correctable memory error logging disabled for a memory device at location <location>.
	Details	Errors are being corrected but no longer logged.
	Action	Review system logs for memory exceptions. Reinstall memory at location <location>.
PCI1302	Message	A bus time-out was detected on a component at bus <bus> device<device> function <func>.

Error Code	Message Information	
	<b>Details</b>	System performance may be degraded. The device has failed to respond to a transaction.
	<b>Action</b>	Cycle input power, update component drivers, if device is removable, reinstall the device.
PCI1304	<b>Message</b>	An I/O channel check error was detected.
	<b>Action</b>	Cycle input power, update component drivers, if device is removable, reinstall the device.
PCI1308	<b>Message</b>	A PCI parity error was detected on a component at bus <bus>device<device>function <func>.
	<b>Details</b>	System performance may be degraded, PCI device may fail to operate, or system may fail to operate.
	<b>Action</b>	Cycle input power, update component drivers, if device is removable, reinstall the device.
PCI1320	<b>Message</b>	A bus fatal error was detected on a component at bus <bus>device<device>function <func>.
	<b>Details</b>	System performance may be degraded, or system may fail to operate.
	<b>Action</b>	Cycle input power, update component drivers, if device is removable, reinstall the device.
PCI1342	<b>Message</b>	A bus time-out was detected on a component at slot <number>.
	<b>Details</b>	System performance may be degraded, or system may fail to operate.
	<b>Action</b>	Cycle input power, update component drivers, if device is removable, reinstall the device.
PCI1348	<b>Message</b>	A PCI parity error was detected on a component at slot <number>.
	<b>Details</b>	System performance may be degraded, or system may fail to operate.
	<b>Action</b>	Cycle input power, update component drivers, if device is removable, reinstall the device.

Error Code	Message Information	
PCI1360	<b>Message</b>	A bus fatal error was detected on a component at slot <number>.
	<b>Details</b>	System performance may be degraded, or system may fail to operate.
	<b>Action</b>	Cycle input power, update component drivers, if device is removable, reinstall the device.
PST0128	<b>Message</b>	No memory is detected.
	<b>Details</b>	System BIOS was unable to detect memory in the system.
	<b>Action</b>	Re-seat the memory modules. If the issue persists, see <a href="#">Getting Help</a> .
PST0129	<b>Message</b>	Memory is detected, but is not configurable.
	<b>Details</b>	System BIOS detected memory, but was unable to configure the memory for system operation.
	<b>Action</b>	Compare system memory installation to supported system memory configurations.
RFM1008	<b>Message</b>	Failure detected on Removable Flash Media <name>.
	<b>Details</b>	An error was reported during a SD card read or write.
	<b>Action</b>	Reseat the flash media. If the problem persists, see <a href="#">Getting Help</a> .
RFM1014	<b>Message</b>	Removable Flash Media <name> is write protected.
	<b>Details</b>	The card is write-protected by the physical latch on the SD card. A write-protected card cannot be used.
	<b>Action</b>	If unintended, remove the media and disable write protection.
SEC0031	<b>Message</b>	The chassis is open while the power is on.
	<b>Details</b>	The chassis is open. System performance may be degraded, and security may be compromised.
	<b>Action</b>	Close the chassis. Check system logs.
SEC0033	<b>Message</b>	The chassis is open while the power is off.

Error Code	Message Information	
	<b>Details</b>	The chassis was opened while the power was off. System security may have been compromised.
	<b>Action</b>	Close the chassis and verify hardware inventory. Check system logs.
SEL0006	<b>Message</b>	All event logging is disabled.
	<b>Details</b>	This message is displayed when all event logging has been disabled by the user.
	<b>Action</b>	If unintended, re-enable logging.
SEL0008	<b>Message</b>	Log is full.
	<b>Details</b>	When the event log is full, additional events are not written to the log. Older events may be overwritten and lost. This message may also appear if the user disabled event logging.
	<b>Action</b>	Backup and clear log.
SEL0012	<b>Message</b>	Could not create or initialize the system event log.
	<b>Details</b>	If the system event log fails to initialize, platform status and failure events are not captured. Some management software do not report platform exceptions.
	<b>Action</b>	Reboot the management controller or iDRAC. Cycle system input power. If problem persists call support.
SEL1204	<b>Message</b>	An unknown system hardware failure detected.
	<b>Details</b>	If the system event log failed to initialize, platform status and failure events are not captured. Some management software do not report platform exceptions.
	<b>Action</b>	Re-configure system to the minimum supported configuration. If issues persists, contact support.
TMP0118	<b>Message</b>	The system inlet temperature is less than the lower warning threshold.
	<b>Details</b>	Ambient air temperature is too cool.
	<b>Action</b>	Check the system operating environment.
TMP0119	<b>Message</b>	The system inlet temperature is less than the lower critical threshold.

Error Code	Message Information	
	<b>Details</b>	Ambient air temperature is too cool.
	<b>Action</b>	Check the system operating environment.
TMP0120	<b>Message</b>	The system inlet temperature is greater than the upper warning threshold.
	<b>Details</b>	Ambient air temperature is too warm or one or more fans may have failed.
	<b>Action</b>	Check the system operating environment and review event log for fan failures.
TMP0121	<b>Message</b>	The system inlet temperature is greater than the upper critical threshold.
	<b>Details</b>	Ambient air temperature is too warm or one or more fans may have failed.
	<b>Action</b>	Check the system operating environment and review event log for fan failures.

## Warning Messages

A warning message alerts you to a possible problem and prompts you to respond before the system continues a task. For example, before you format a hard drive, a message warns you that you may lose all data on the hard drive. Warning messages usually interrupt the task and require you to respond by typing y (yes) or n (no).

 **NOTE:** Warning messages are generated by either the application or the operating system. For more information, see the documentation that accompanied the operating system or application.

## Diagnostic Messages

The system diagnostic utilities may issue messages if you run diagnostic tests on your system. For more information about system diagnostics, see [Using System Diagnostics](#).

## Alert Messages

Systems management software generates alert messages for your system. Alert messages include information, status, warning, and failure messages for drive, temperature, fan, and power conditions. For more information, see the systems management software documentation.



# Getting Help

## Contacting Dell

 **NOTE:** Dell provides several online and telephone-based support and service options. If you do not have an active Internet connection, you can find contact information on your purchase invoice, packing slip, bill, or Dell product catalog. Availability varies by country and product, and some services may not be available in your area.

To contact Dell for sales, technical support, or customer-service issues:

1. Visit **dell.com/support**.
2. Select your country from the drop-down menu on the top left corner of the page.
3. For customized support:
  - a) Enter your system service tag in the **Enter your Service Tag** field.
  - b) Click **Submit**.The support page that lists the various support categories is displayed.
4. For general support:
  - a) Select your product category.
  - b) Select your product segment.
  - c) Select your product.The support page that lists the various support categories is displayed.

## Locating Your System Service Tag

Your system is identified by a unique Express Service Code and Service Tag number. The Express Service Code and Service Tag are found on the front of the system by pulling out the information tag. This information is used by Dell to route support calls to the appropriate personnel.

## Documentation Feedback

If you have feedback for this document, write to **documentation\_feedback@dell.com**. Alternatively, you can click on the **Feedback** link in any of the Dell documentation pages, fill out the form, and click **Submit** to send your feedback.

## Quick Resource Locator

Use the Quick Resource Locator (QRL) to get immediate access to system information and how-to videos. This can be done by visiting **dell.com/QRL** or by using your smartphone and a model specific Quick Resource (QR) code located on your Dell PowerEdge system. To try out the QR code, scan the following image.

